



# TpacadNt

Version 2.4.21

***TpaCADNT***

---



Tecnologie e Prodotti per l'Automazione

This documentation is property of TPA S.r.l.  
Any unauthorized copy is forbidden.  
The Company reserves the right to modify the content of the  
document at any time.

# Table of contents

<b>1</b>	<b>Nesting of programs</b>	<b>1</b>
1.1	Overview	2
1.2	Cutting technology	2
<b>2</b>	<b>Project of Nesting (*.ncad)</b>	<b>4</b>
2.1	Menu	4
2.2	Pieces and Clusters	9
	Create and edit a cluster	13
2.3	Sheets	14
2.4	Customizations	15
<b>3</b>	<b>Nesting solution procedure</b>	<b>18</b>
3.1	Correspondence groups	20
3.2	Multiple pieces and multiple panels	21
3.3	Single piece and single panel	21
3.4	Multiple pieces and single panel	21
3.5	Single piece and multiple panels	22
3.6	Applied criteria and filters	22
3.7	Best solution	23
	Solution of Rectangular nesting	24
	Solution of Nesting True shape	24
3.8	Step-by-step solution (Rectangular Nesting)	25
<b>4</b>	<b>Nesting results</b>	<b>27</b>
4.1	Error situations	28
4.2	Representation of the panels	28
	Solution (EXAMPLE #1)	30
	Solution (EXAMPLE #2)	31
	Solution (EXAMPLE #3)	32
	Solution (EXAMPLE #4)	34
4.3	Cutting paths	34
4.4	Cut of the scraps	36
4.5	Labels	36
<b>5</b>	<b>Save the results</b>	<b>38</b>
5.1	Organization of panels	40
5.2	Save results on completion	41
5.3	Save unused pieces	41
<b>6</b>	<b>Prototype of nesting panels</b>	<b>42</b>

<b>7</b>	<b>Save the executive list</b>	<b>43</b>
<b>8</b>	<b>Remove nesting results</b>	<b>44</b>
<b>9</b>	<b>Nesting report</b>	<b>45</b>
	9.1 Report ("*.XML" format)	45
	9.2 Report ("*.PDF" format)	47
<b>10</b>	<b>Print labels</b>	<b>49</b>
<b>11</b>	<b>Nesting configuration</b>	<b>50</b>
	11.1 Pieces	50
	11.2 Sheets	51
	11.3 Exclusions	51
	11.4 Nesting options	51
	11.5 Sorting logic	54
	11.6 Cutting profiles	55
	11.7 Enable	59
	11.8 Label Wizard	63
	Example of label with edges indicated	70
	Example of label with QR code	72
<b>12</b>	<b>Nesting in Demo mode</b>	<b>73</b>
<b>13</b>	<b>Format of a file (.ncad)</b>	<b>74</b>
	13.1 Parameter Section	75
	13.2 Piece Section	77
	13.3 Section of manual clusters	80
	13.4 Sheet Section	83

# 1 Nesting of programs

The *Nesting* functionality adds a tabulation to the main menu of TpaCAD and is active when the CAD program is closed.



To start the Nesting functionality, select the **Enable "Nesting"** command: this enables the entries of the associated menu and makes the associated section visible.



To close the Nesting functionality, select the **Close "Nesting"** command.

The TpaCAD graphic interface appears as modified:

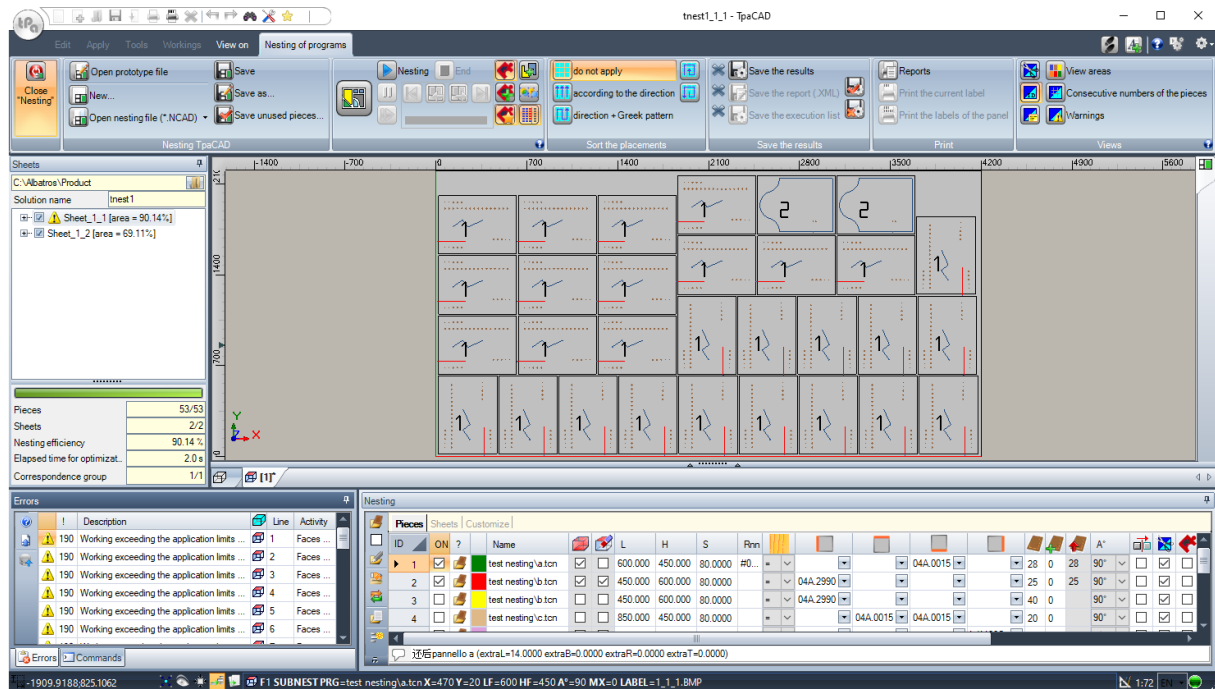

The tabulation of the menu shows 6 groups of commands:

- **Nesting TpaCAD:** groups together the commands to manage a Nesting program (New, Open,...). A Nesting program is an XML format file with (.NCAD) extension. The figure shows that the program called *tnest1.ncad* is open: the program is assigned in the Nesting section in the area already used for the assignments of a piece program.
- **Nesting:** a second group includes the commands to run a nesting program: assignments concerning the procedure and calculation of placements.
- **Sort the placements:** commands to select the type of sorting required for placements on a sheet (see chapter: *Nesting configuration* -> *Sorting logic*)
- **Save the results:** commands to record nesting panels, to create and save the report file (".XML" format) and the execution list
- **Views:** commands of graphic option for the panels of nesting. The figure shows the first panel produced, where the options to view the rectangle of each positioning, the workings applied, and the numeric identifiers of the pieces have been activated.
- **Print:** creation and storage of the Report file or label print.

The section is made of three pages to assign:

- **Pieces:** list of the pieces for which the positioning is required
- **Sheets:** list of the panels (sheets) on which the placements can be carried out.
- **Customize:** selections and settings to customize the nesting procedure.

The information of this section is a Nesting program and is stored in files with (".NCAD"). extension.

On the left of the graphic area the field for the final panels ("\*.TCN" files) is provided, as shown in the figure with the name of *Sheets*:

-  click to choose where to create the folder for the solution
- **Name**: sets the name of the solution and of the nesting program (\*.NCAD" file). A folder with the assigned name is created in the folder selected above into which the panels of the solution (.TCN format programs) are stored. The name of the panels is determined by a common matrix given by the **Name**.
- The intermediate zone contains a tree view for displaying the manufactured panels, where the main nodes correspond to the panels. With reference to the solution in the figure:
  - the active node in the list corresponds to the Panel represented in the graphic area
  - any expansion of the node provides the information for each type of piece applied (numeric ID and colour, as assigned in the section of Nesting)
- The lower part of the area shows cumulative information on nesting solution:
  - pieces placed on the total required. If manual cluster management is enabled, the number of clusters placed + the number of pieces placed is displayed
  - panels used on the total available
  - overall nesting efficiency, evaluated as the ratio between the area used for the placements and the total area of the panels used.

## 1.1 Overview

The *Nesting of programs* functionality places a list of pieces inside one or more panels (or Sheets), maximizing the number of the panels needed and compacting the individual placings. The pieces to be positioned can be programmed in TCN format, rectangular geometries or drawings.

The result of a *Nesting* is the storage of the list of panels that match the position required; each panel is a program in TCN format that applies cutting profiles of the various positionings and possibly programmed workings in original pieces. Below, the term *solution* will identify the set of TCN panels recorded after a *Nesting*.

The use of the *Nesting of programs* functionality needs a specific qualification from Hardware key and a qualification during TpaCAD configuration (see **Environment->Components**).

Some conditions apply to TpaCAD configuration:

- face 1 (top) management must be active and the face geometry must be the absolute Cartesian triad
- there must be some significant codes available in the working database (assigned in the basic database).

The functionality qualification is independent on the level of the TpaCAD program (Essential, Base or Professional) and it has two possible levels of functioning:

- Rectangular Nesting
- Nesting True Shape

The *Rectangular Nesting* manages the pieces positioning applying dispositions that respect the rectangles of the overall dimension (bounding-box) of each individual piece.

The *Nesting True Shape* manages the pieces positioning by applying dispositions that respect the real overall dimension of each individual piece. The application of the *True Shape* functioning is influenced by the piece type, as better specified below. With the *True Shape* level, the manual cluster functionality is also enabled.

Pieces that can be positioned are differentiated into four possible types and for each type one and/or both nesting logic can be applied.

Ancillary functions concern the management of Labels, Report files and the Execution list.

The Nesting functionality is activated only after checking some conditions.

## 1.2 Cutting technology

The validity of the technology that will be used for developing the cutting paths of the panels will be checked.

Cutting technology can be assigned in two ways:

- by showing a global technology (see: Nesting configuration); or
- by programming a setup working in the file used as a template for creating nesting panels (see below, in the **Prototype of nesting panels**)

The cutting technology determines the setup working to be used and all the appropriate technological assignments: machine, group, tool, speed, properties. More specifically, a tool positive number and a  $>10.0 * \epsilon$  diameter must be assigned.

Only if you enable the Demo functionality, the failure of the technology check does not block the activation of Nesting since this functionality excludes the generation of cut paths.





If the technology fails, Nesting cannot be further activated. The error situation is highlighted by the message: "Selecting a functionality requires the assignment of a valid technology for the cutting profiles".

An alert, instead, can concern the management of the labels, when a valid layout is not assigned for their generation. In this case, it is an alert and not an error: continuing on track, the management of the label will not be active.

## 2 Project of Nesting (\*.ncad)

The solution of a Nesting begins with writing a program/program of nesting: as already mentioned, it is a file in XML format, recorded with (".NCAD") extension.



In the menu we find the usual commands to manage the files here specialized for a (".NCAD") program:

- 
**New:** a nesting project is created starting from a prototype program (NESTCAD.NCAD, in the folder: TPACADCFG\CUSTOM\NESTING).  
 The start of the nesting functionality opens a new project.  
 The project is automatically assigned a name with a progressive number (examples: "tnest1", "tnest2",..).
- 
**Open nesting file (\*.NCAD):** opens an already stored nesting program. When the Nesting functionality is activated, you can also open a nesting project by dragging a (.ncad) file, for example from Resource management and dropping it inside the TpaCAD workspace.  
 The button can open a menu that allows you to directly select a nesting program, choosing from the last ones opened.  
 If the nesting program uses types of pieces that are not managed, it is possible to confirm their opening by assigning the pieces to the **Rectangle** type (see: next paragraph).
- 
**Save:** save the program now open. If the program is new, the **Save as** command is called.
- 
**Save as:** saves the program now open, where it is possible to assign the file name and place. If the program is new, the storage default folder (PRODUCT\NESTING) is suggested.  
 In the event of saving by changing the project name and if some nesting results (nesting panels, labels, execution list, report) have been stored, you can confirm their deletion. However, they will need to be re-registered, as the destination folder and names will have changed.
- 
**Open prototype file:** opens the prototype program (NESTCAD.NCAD in folder: TPACADCFG\CUSTOM\NESTING), and creates it, if it does not exist.  
 Nesting prototype project assigns the panel list and the customization page. On the other hand the page of the piece list is not proposed.





Let us now examine in detail the Nesting section.

### 2.1 Menu

In addition to the three pages already mentioned, this section has a local menu which is active by selecting the first two pages. The composition of the menu may change according to the options of the Configuration of the Nesting functionality.

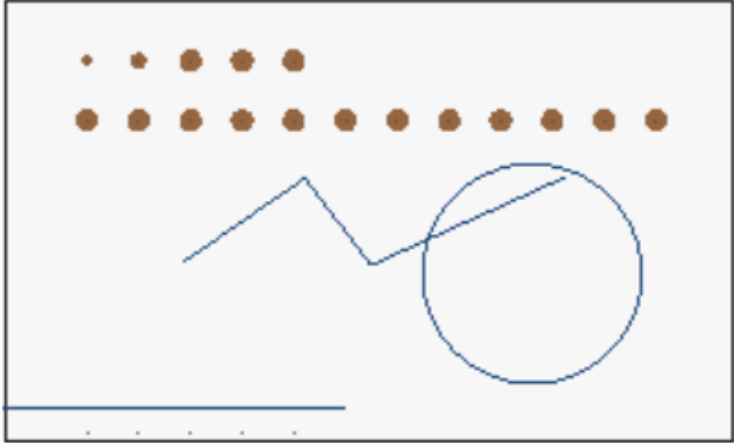
	<p>It opens a single or multiple selection window of programs to directly insert one or more lines in table in correspondence with the type of <b>Panel (*.TCN)</b>.</p> <p>Depending on the version installed, the button may directly manage the automatic recognition of the type of <b>Shaped workpieces</b>, also incorporating the operation of the button  (see below).</p> <p>The single or multiple selection mode is determined by the status of the <b>Insert a single file</b> button (see below).          However, the insertion of more than one line is limited to a maximum number of 300. You can select a list of piece programs (TCN format) or import files in a different format (for example: DXF). In this latter case, the files are first converted first into TCN format and then automatically added to the list of parts to be nested. Situations of failed conversion are reported in the same context of the command execution.</p>
---	---



	<p>A possible format conversion takes place applying the same criteria valid for a normal program opening in the main TpaCAD menu. Under request of positioning the programmed workings (see: selection in <i>Customizations</i> page), only the workings on top face (and on bottom face too, if <i>Nesting-flip</i> function is active) are applied.</p> <p>The positioning of a <i>Panel (*.TCN)</i> :</p> <ul style="list-style-type: none"> <li>• may require/exclude the execution of programmed workings in the upper face and, in the case of requested execution:</li> <li>• examines the programmed workings, in order to evaluate executions outside the original or modified dimensions of each program. External overall dimensions lead to the use of a respect area around the dimensions, in order to safeguard the contiguous positioning</li> <li>• the positioning is resolved <b>in any case</b> with logic of <i>Rectangular nesting</i></li> <li>• can activate/deactivate the possibility of a 90° rotation</li> <li>• it can request a specular positioning of the workings</li> <li>• it can request/exclude the cut profile.</li> </ul> <p>In figure an example of <b><i>Panel (*.TCN)</i></b></p>  <p>It is clear the presence of workings of different types: drillings, closed or opened profiles. The positioning is resolved by considering the rectangle of overall dimension of the panel as defined by the configured dimensions <i>Length</i> and <i>Height</i>, with possible 90° rotation.</p>
	<p>It inserts a line in the table of <b><i>Rectangle</i></b> type</p> <p>The positioning of a <i>Rectangle</i>:</p> <ul style="list-style-type: none"> <li>• is <b>in any case</b> resolved through logic of <i>Rectangular nesting</i></li> <li>• can activate/deactivate the possibility of a 90° rotation</li> <li>• creates anyhow cutting profiles</li> </ul>
	<p>It opens a single or multiple selection window of programs to directly insert one or several lines in table in correspondence with the type of <b><i>Shaped workpieces</i></b>.</p> <p>Depending on the version installed, the button may directly manage the automatic recognition of the type of <b><i>Shaped workpieces</i></b>, also incorporating the operation of the button  (see above).</p> <p>However, the insertion of more than one line is limited to a maximum number of 300.</p> <p>As it is already for the type <i>Panel (*.TCN)</i>:</p> <ul style="list-style-type: none"> <li>• it is possible to select a list of piece programs (TCN format), or to import files in different format (for example: DXF). In this second case, the files are firstly converted in TCN format and later, automatically added to the piece list where to perform the nesting;</li> <li>• a possible format conversion takes place applying the same criteria valid for a normal program opening in main TpaCAD menu;</li> <li>• only the workings on upper face are applied.</li> </ul>

Panels in the list *must* now assign a closed profile characterized as *Nesting geometry*:

- only one profile can be recognized as *Nesting geometry*: the first one assigned with **Technological priority** with value 0
- *construct* profiles are excluded from the analysis
- on assessing the profile geometry (if closed or not), the entry/exit segments programmed on the setup are excluded, they are instead taken into consideration on assessing the total overall dimension of the profile
- comparing points applies a technological epsilon equal to the diameter of the tool assigned to the profile itself, here indicated as *epsTec*
- the profile is considered closed, if one of the following conditions is verified:
  - ✓ the distance between the start and end point is less than *epsTec*
  - ✓ the profile executes a circle or a complete ellipse
  - ✓ the first segment ends on the starting point of the last segment (the distance is lower than *epsTec*)
  - ✓ the profile starts and ends with intersecting segments
  - ✓ the minimum distance between the ending point and the first segment is lower than *epsTec*
  - ✓ the minimum distance between the starting point and the last segment is lower than *epsTec*.

The assessments of intersection and distance are calculated upon the development of the segments on the XY plane.

The figure shows examples of profiles considered as closed (in the figure we can see the direction arrows, the ending points of the segments, and the circle representing the overall dimension of the tool on the setup position)



Otherwise, an error warning will appear, that can be resolved taking back the piece type to *Panel (\*.TCN)*.

Other possible closed profiles in the *Nesting geometry* can be characterized as *Scrap geometry* and be used as useful areas for further positioning:

- only the profiles with **Technological priority** with value 0 are considered as scrap profiles
- the same above-mentioned criteria are applied when evaluating the geometry of the off-cuts profiles
- the entry/exit segments, programmed on the setup, are totally excluded from the geometry evaluation and the overall dimension of the off-cuts profiles. In case that the same segments are programmed, no evaluation is performed to check if they are correct (read: they are not external to the scrap area and, in the case of internal segments, the positioning in the scraps cannot be requested).
- internal positioning also require that the off-cuts profiles are mutually external.



If the *Nesting-flip* function is active: only profiles defining *Nesting geometry* and *Scrap geometries* programmed in face 1 (top) are evaluated.







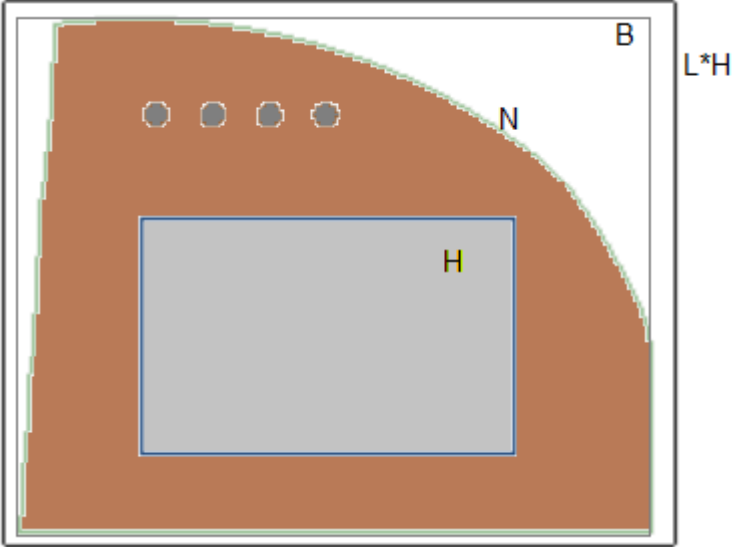

Other workings present in top face of the program (and/or bottom face, with *Nesting-flip* active) are regularly assigned for the execution. No check controls if the *Nesting geometry* contains the other workings of the program and no evaluation is now carried out with regard to the determination of additional overall dimensions, as is the case of the **Panel (\*.TCN)** type.



The positioning of a *Shaped workpiece* can be solved with logic of *Rectangular nesting* or *Nesting True Shape*.

In case of positioning with a logic of *Rectangular nesting*:

- it uses the positioning on the rectangle of overall dimension of the profile characterized as *Nesting geometry*
- with appropriate enabling in *Configuration*, it is possible to examine the other programmed workings, in order to evaluate executions outside the bounding box

	<p>of the <i>Nesting geometry</i>. External dimensions lead to the use of a respect area, so as to safeguard the placements adjacent to the <i>Nesting geometry</i>.</p> <ul style="list-style-type: none"> <li>• it can enable/disable the possibility of a 90° rotation (counterclockwise)</li> <li>• it can request a specular positioning of the workings</li> <li>• it is not possible to carry out positioning within possible scrap profiles.</li> </ul> <p>In case of positioning with a logic of <i>Nesting True Shape</i>:</p> <ul style="list-style-type: none"> <li>• it uses the positioning on the real overall dimension of the profile characterized by <i>Nesting geometry</i></li> <li>• it can activate/deactivate the possibility of 90° step rotation or of any other angle (example: 30°)</li> <li>• it can request a specular positioning of the workings</li> <li>• it is possible to perform positioning within possible scrap profiles</li> </ul> <p>The positioning does never create a further cut path.</p> <p>In figure an example of possible <b>Shaped workpiece</b>:</p>  <p>Areas and remarkable elements are marked with colours and letters:</p> <ul style="list-style-type: none"> <li>✓ <b>N</b> is the profile marked as <i>Nesting geometry</i> (necessary)</li> <li>✓ <b>H</b> is the profile marked as <i>Scrap geometry</i> (optional)</li> <li>✓ <b>B</b> is the rectangle of overall dimension of the <b>N</b> profile</li> <li>✓ <b>L*H</b> is the perimeter of the TCN program, assigned on the dimensions (length * height)</li> <li>✓ some elements linked to drillings are clear within a <b>N</b> profile.</li> </ul> <p>In case of application of the logic <i>Rectangular nesting</i>:</p> <ul style="list-style-type: none"> <li>• the positioning is resolved considering the rectangle of overall dimension marked by <b>B</b>, with possible counterclockwise rotation of 90°</li> <li>• the rectangle of overall dimension <b>B</b> is determined by including the overall dimension of the technology that is programmed for the <b>N</b> profile.</li> <li>• no positioning can be performed within an area marked by <b>H</b>.</li> </ul> <p>In case of application of the logic <i>Nesting True Shape</i>:</p> <ul style="list-style-type: none"> <li>• the positioning is resolved considering the overall dimension of the <b>N</b> profile, with possible step rotations of 90° or of a different angle (example: 30°)</li> <li>• the area marked by <b>H</b> can be used to place other pieces managed with <i>Nesting True Shape</i> logic (from other lines in the table)</li> <li>• for both <b>N</b> and <b>H</b> profiles the programmed technology is taken into consideration</li> </ul>
	<p>It opens a single or a multiple selection window of files in DXF format (and eventually DWG) to directly insert one or several lines in the table in correspondence with the type of <b>Nesting geometry</b>. However, the insertion of more than one line is limited to a maximum number of 300.</p> <p>The DXF file/s must abide by particular rules and are imported in specific mode.</p>

	<ul style="list-style-type: none"> <li>files must be assigned as bi-dimensional and no interpretation is realized for levels and/or blocks</li> <li>the only elements taken into consideration assign <i>closed</i> profiles like: arcs, circles, polylines, splines, ellipses</li> <li>among all the elements read, the profile with the largest overall dimension (calculated as area of the overall rectangle) is imported together with its possible islands (on the first level), while all the other elements are rejected</li> <li>a profile is imported as an island only if it is inside the profile with the largest overall dimension</li> <li>the main profile is used by <i>Nesting geometry</i> and the others by <i>Scrap geometry</i>.</li> </ul> <p>The same criteria as above are applied when evaluating the profile geometry (see references to <i>epsTec</i>). Furthermore, a profile with intersecting traits is considered valid.</p> <p>The DXF file is interpreted with the same unit of measurement as the one of the Nesting project.</p> <p>The import of the DXF file is only temporary and does not create any TCN file.</p> <p>The positioning of a <i>Nesting geometry</i> can be resolved with a logic of <i>Rectangular nesting</i> or of <i>Nesting True Shape</i>, in a similar mode to the previous (<b>Shaped workpiece</b>). The only difference is that other workings besides the <i>Nesting</i> and <i>Scrap geometry</i> cannot be resolved.</p> <p>To all profiles is assigned the reference technology for the nesting functionality (or another, as configured in <b>Nesting configuration</b>)</p>
	<p>Opens a window for defining a manual cluster. The window is displayed if at least one piece is defined. In each cluster 100 parts can be defined, and a maximum of 100 clusters can be defined.</p> <p>When the window is closed, a row of manual cluster type is inserted.</p>
	<p><b>Insert a single file</b></p> <p>Select to activate the single selection of files on the previous commands: in this case the opening of the resource management window controls the graphic preview of the selected file.</p> <p>Inactive selection: leads to the management of multiple selection windows of homogeneous files by type (examples: *.TCN, *.DXF).</p>
	<p>It restores the original settings of the piece programs (TCN format). The settings that can be restored are related to:</p> <ul style="list-style-type: none"> <li>dimensions (LxHxS), units of measure, grain, edges: they are assigned to the original values of the program</li> <li>'r' variables: each external assigned is reset.</li> </ul>
	<p><b>Import from the list</b></p> <p>It opens a window to select a list file in CSV format (for the interpretation of the format see <b>Nesting configuration</b>).</p> <p>A list file corresponds to a list of programs to be added to the list, each with application of specific assignments (size, quantity, grain,...): it can be generated, for example, by an application of cabinet design.</p> <p>Type of the added programs: <b>Panel (*.TCN)</b>.</p> <p>The list file must assign files all of the same type and automatically recognizes an importable format (ex.: DXF).</p> <p>The command is not available, if no format is assigned for the interpretation of the same file.</p> <p>If manual Cluster is enabled in Nesting Configuration, it is possible to import programs that define a cluster.</p> <p>It is also possible to read and apply a specific format interpreting the first row of the file, if this is recognized as a valid header row: in this case, a window to confirm will be presented. A header row must have the same format as indicated in <b>Nesting configuration</b>.</p>
	It inserts a row in the table of the page, copying the current line
	It deletes the selected rows or the current row
	It deletes all the rows of the table
	It moves the current row to the previous or the following position in the table









	Remember that when performing the nesting procedure, the position in the list is still a criterion for sorting the pieces.
	<p><b>Preview</b></p> <p>Select to activate the opening of the graphic preview in correspondence with the current line of the table.</p> <p>The graphic preview window is opened only at the current line, moving the mouse within the program <i>Name</i> cell. The user can also deactivate this selection by closing the window manually.</p>
	It opens the context help of the current chapter.







## 2.2 Pieces and Clusters





**Pieces:** a row of the table assigns a program of a type among those mentioned above (normally a TCN program). It is possible to assign up to 300 pieces. The table composition may change depending on the options of the Nesting functionality configuration.

**Clusters:** if manual cluster management is enabled, a manual cluster can be defined at the end of the pieces. It is possible to assign up to 100 clusters.

ID	Progressive number automatically assigned and used as a unique identifier (ID) of the table row
ON	<p>Select this box to enable using the row.</p> <p>Select the header cell of column to change the box of all the rows in the table (if some rows are selected, the change is limited to these).</p>
?	<p>It shows the icon corresponding to the element type.</p> <p>In the event of <b>Panel (*.TCN)</b> or <b>Shaped workpiece</b>, a double-click on the box exchanges the type. The new selection can determine or solve a diagnostic warning.</p> <p>In the case of manual cluster, a double click on the box opens the cluster modification window.</p>
	<p>The column is automatically managed and matches a unique colour with the table row.</p> <p>It is possible to modify the colours used for each row in <i>Customization of TpaCAD</i>.</p>
Name	<p>It identifies the program: a double-click on the cell opens the window to select the program.</p> <p>When <b>Preview</b> is enabled, moving the mouse on the cell of the current row, a local window with a graphic representation of the program is opened.</p> <p>If you assign a <i>Description</i> to the program, this description is displayed in the lower field of the page at the current row in the table.</p> <p>In the event of <b>Rectangle</b> type, the field may not be editable or, if editable, it allows a direct assignment of a name to the element.</p> <p>In case of <b>manual Cluster</b> the field is assigned automatically and can be modified.</p>

 Program with workings in other faces	This information is automatically filled in: the selected box shows that in the original program the workings are programmed on faces different from the face of nesting (upper face) and that can be only related to the cases of positioning of TCN program (type <b>Panel (*.TCN)</b> or <b>Shaped workpiece</b> )  In the case of <b>manual Cluster</b> information is not significant.
 Excluded workings	The information is automatically filled in and is significant after the solution of the Nesting; the selected box shows that workings of the program have been excluded in the solution of the Nesting and that can only be related to the cases of positioning of TCN program.  In the case of <b>manual Cluster</b> information is not significant.
L (Length)	Length of the program (original of the file or modified)  It is flagged as error if a value lower than 20.0 mm (0.787 inch) is set.  In the case of <b>manual Cluster</b> information is not significant.
H (Height)	Height of the program (original of the file or modified)  It is flagged as error if a value lower than 20.0 mm (0.787 inch) is set.  In the case of <b>manual Cluster</b> information is not significant.
S (Thickness)	Thickness of the program (original of the file or modified)  Select the header cell of the column to change the box of all rows in the table for the value of the current row (if there are selected rows, the change is limited to these ones).
 Grain direction	Grain of the panel (original or modified).  A list of 3 items is assigned as follows: <ul style="list-style-type: none"> <li>• "=": no grain direction</li> <li>• "X": horizontal direction</li> <li>• "Y": vertical direction.</li> </ul> If the program assigns an original (horizontal or vertical) grain, a change can only reset the field. For example: it is not possible to switch the original grain of a program from horizontal to vertical, while it is possible to switch from horizontal to <i>not assigned</i> .  If the grain is assigned in a cluster: <ul style="list-style-type: none"> <li>• If grain <b>X</b>, parts can assign either no grain (=) or grain <b>X</b></li> <li>• If grain <b>Y</b>, parts can assign either no grain (=) or grain <b>Y</b></li> <li>• If no grain (=) is assigned in the cluster, then all parts must not assign any grain (=)</li> </ul>
 Left edge  Top edge  Bottom edge  Right edge	Panel edges, sorted by side (original of the file or modified).  The setting can either be direct, with an assigned edge code whose maximum length is 25 characters, or with selection from a list of preset codes.  If the program assigns original edges, a modification can reset or change the field.  The edges assigned in the cluster during nesting replace the edges assigned in the parts.
Rnnn	A click on the cell opens the window to assign the public <r> variables of the program. The box is only activated in case of positioning of <b>Panel (*.TCN)</b> or <b>Shaped workpiece</b> .  In the case of <b>manual Cluster</b> information is not significant.
 Available quantity	Quantity to place: set a positive value (>=0) not greater than 999. Select the header cell of the column to change the value of all the rows for the value of the current row.  In the case of <b>manual Cluster</b> , if all parts used in the cluster have assigned value 0, then only the number of cluster quantities is considered and there will be no residual quantities in the parts.

 <p>Maximum quantity</p>	<p>A value greater than the previous one assigns the maximum usable quantity (not greater than 999):</p> $(\text{Maximum quantity}) - (\text{Available quantity}) = \text{quantity that can be used to fill up the assigned panels, only after placing or trying to place the available Quantities of all the piece types.}$ <p>The assignment is significant only if (Available quantity) sets a strictly positive value (&gt;0).</p> <p>Select the header cell of the column to change the value of all the rows for the value of the current row.</p>
 <p>Quantity used</p>	<p>The column is managed automatically and shows the quantity actually used after the Nesting solution.</p> <p>A red cell background indicates that the number of pieces or clusters lower than the required amount was used.</p>
<p>Rotation</p>	<p>The column can assign simple check boxes or a three-item list, the latter if the Nesting <i>True Shape</i> functionality results active.</p> <p>Select the box to enable the positioning of the piece also with 90° rotation.</p> <p>If the box is not selected, the piece can only be positioned as it was originally positioned.</p> <p>The selection in the list also proposes the option <i>any</i>, that corresponds to the selection to step rotate a considerable angle, as assigned in the <i>Nesting Configuration</i>. The application of the <i>any</i> rotation is only possible in case of <i>True Shape</i> placement.</p> <p>Select the header cell of the column to change the value of all the rows in the table for the current row selection.</p> <p>Limits to rotation of a TCN program may result from:</p> <ul style="list-style-type: none"> <li>• workings to carry out. If, for example, a program requires the execution of a sawing work, any rotation of the positioning will not be applied;</li> <li>• evaluations of panel material (presence of grains).</li> </ul>
<p>Mirror</p>	<p>Select the box to request the execution of the piece in mirror mode along the horizontal axis.</p> <p>Select the header cell of the column to change the value of all the rows in the table for the current row selection.</p> <p>Limitations to the mirroring of a TCN program may derive from programmed workings: in this case the part will not be placeable.</p>
 <p>Cutting profiles</p>	<p>Deactivate the box to exclude the creation of the cutting profile of the piece.</p> <p>The selection is only significant in case of the <b>Panel (*.TCN)</b> type.</p> <p>In the case of <b>manual Cluster</b> information is not significant.</p>
 <p>Allow placements in the holes</p>	<p>Select the box to allow placements within the profiles marked as <i>Scrap Geometries</i>.</p> <p>The column may not be visible, and the selection is significant only in case of <i>True Shape</i> placements.</p>
 <p>Automatic clusters</p>	<p>Select the box to enable the application of the automatic cluster of the piece with respect to the single positioning (see below for further details).</p> <p>The column may be not visible, and the selection is significant only in case of <i>True Shape</i> placements.</p> <p><u>The setting assigned in the cluster during nesting replaces the one assigned in the parts.</u></p>
	<p>Select this box to request a placement following a matrix development (see below for further details).</p>

<p>Grid placements</p>	<p>The column may be not visible, and the selection is significant only in case of <i>True Shape</i> placements.</p> <p>The setting assigned in the cluster during nesting replaces the one assigned in the parts.</p>
<p>Material</p>	<p>Select the material of the panel with which the placements can be associated (default selection: Generic).</p> <p>Select the header cell of the column to change the value of all rows to the current row selection.</p> <p>The material assigned in the cluster replaces the material assigned in the cluster parts.</p>
 <p>Colour</p>	<p>Select the colour of the panel with which the placements can be associated.</p> <p>Select the header cell of the column to change the value of all the rows to the current row selection.</p> <p>The colour assigned in the cluster replaces the colour assigned in the cluster parts.</p>
 <p>Priority</p>	<p>Pieces with assigned priority (default value: 0; maximum value:100) take precedence in the nesting solution. How the priority value is interpreted is defined in the option Lower priority with increasing value in Nesting configuration.</p> <p>Select the header cell of the column to change the value of all the rows for the value of the current row.</p> <p>The setting assigned in the cluster during nesting replaces the one assigned in the parts.</p>
 <p>Order reference</p>	<p>The configuration can specify a reference for the client and/or the order and/or the order number of the individual piece.</p> <p>Select the header cell of the column to change the value of all the rows for the value of the current row.</p> <p>The setting assigned in the cluster during nesting replaces the one assigned in the parts.</p>
 <p>Added Info</p>	<p>A click on the cell opens the window to assign the Added Info fields of the individual piece.</p> <p>According to the configuration, it is possible to assign up to a maximum of 10 settings.</p> <p>The setting assigned in the cluster during nesting replaces the one assigned in the parts.</p>
 <p>Label images</p>	<p>A click on the cell opens the window to assign images to labels. Up to 3 images can be set, and in order to display them in a label, ID_IMAGECUSTOM field must be set in the <b>Label Wizard</b> according to the rules defined in the chapter <b>Label Wizard</b></p>

Regarding the case of **Panel (\*.TCN)**, the figure shows the effect of selecting **Rotation** and **Mirror** in 4 possible cases:

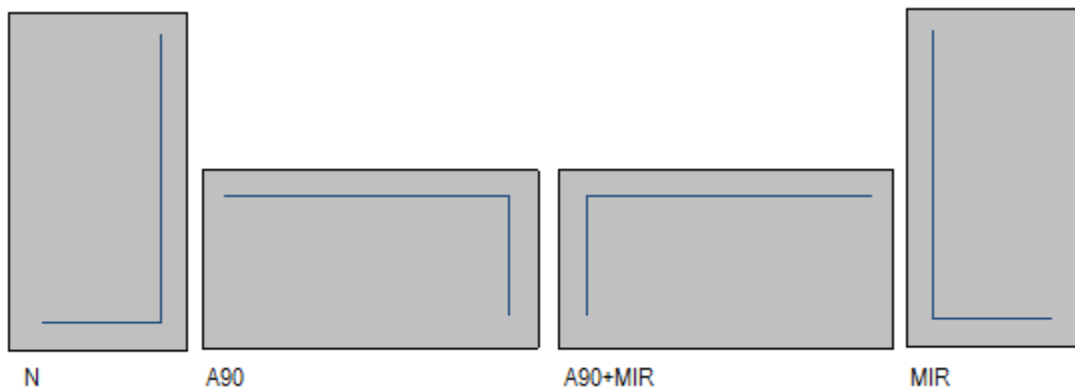

Case 'N': normal positioning



Case 'A90': rotated positioning  
 Case 'A90+MIR': rotated and mirrored positioning  
 Case 'MIR': mirror positioning

## Create and edit a cluster

A cluster is a set of multiple parts that are nested while maintaining the mutual positions defined by the operator. To open the cluster creation window, select the icon  in the menu bar, while to edit a cluster you have to double click on the icon in the "?" column.

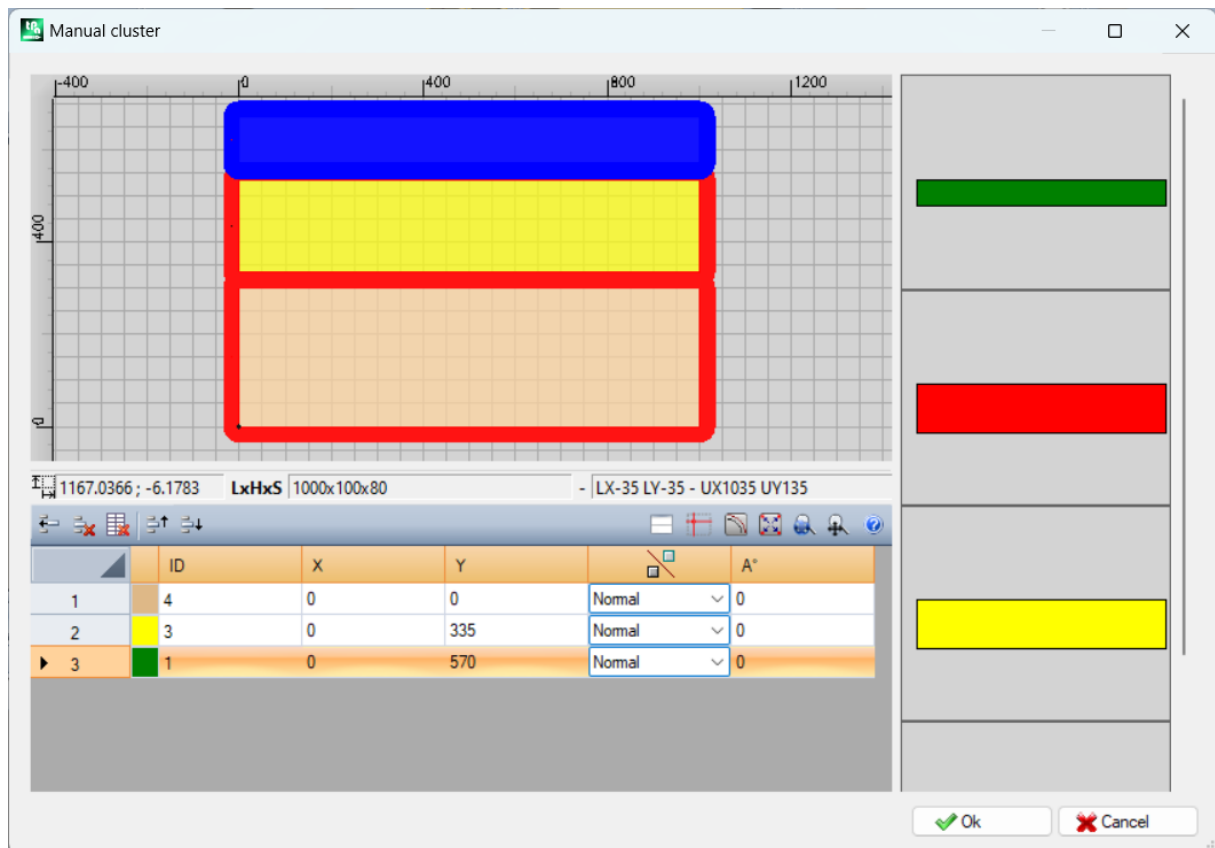













The window consists of three areas:

- parts list area: it is located on the right side of the window. Presents all parts, which can be clustered graphically. With the "drag and drop" they are inserted in the graphic area. The colour with which they are represented is the same that is associated with the part in the parts table.
- graphics area: it is located in the upper part. It is the area useful for positioning each single part. Parts can be moved by dragging the mouse or dimensions can be entered in the X and Y fields of the parts list. Each part can be rotated and can be mirrored along the X axis or Y axis or X+Y axis
- cluster parts list area: located at the bottom of the window. It is the list of parts that are part of the cluster. Each part can be copied, deleted or moved within the list.

Part placement is made with the mouse, with cursor keys, or by placing the coordinates of the application point in the part list table.

Placement aid is provided with the corner snap tool, which can only be used to place parts like rectangle, panel and shaped rectangular pieces, that are not rotated or are rotated with multiple angles of 90 degrees. It can be activated by holding down the **[SHIFT]** key and then moving the part towards the snap point. Snap is made to the part corners. If there are multiple possible snap points overlapping, the one closest to the direction in which the part moves is chosen.

Command Toolbar:

	Duplicate the selected row
	Delete the selected line
	Delete all rows from the table
	Move the selected row to the previous position
	Move the selected row to the next position
	Enables or disables the display of a cross cursor, which locates the application point for rotation, symmetry and positioning of the part in the graphics area
	Enables or disables collision control between parts
	If enabled, it displays the profile overall dimension with linear segment, otherwise it displays the profile overall dimension with filled segment
	If enabled, it displays the placement reference of the part
	Enables window zoom which allows you to enlarge the graphics area selected with the mouse
	Sizes the graphics area so that all inserted parts are displayed
	Calls manual cluster window help

Positioning the pieces in the graphic area using the keyboard:

Cursor keys	Moves the selected part in the direction of the arrow by 1 (millimeters or inches depending on the unit of measurement)
CTRL+cursor keys	Moves the selected part in the direction of the arrow by 5 (millimeters or inches depending on the unit of measurement)
'+' key on the numeric keypad	If the selected part is a shaped piece, it rotates one degree counter-clockwise. If the part is a rectangle or a panel, it rotates 90 degrees counter-clockwise
'-' key on the numeric keypad	If the selected part is a shaped piece, it rotates one degree clockwise. If the part is a rectangle or a panel, it rotates 90 degrees clockwise
CTRL+ '+' on the numeric keypad	If the selected part is a shaped piece, it rotates 5 degrees counter-clockwise
CTRL+ '-' on the numeric keypad	If the selected part is a shaped piece, it rotates 5 degrees clockwise
Shift+move a part with the mouse or cursor keys	Enables handling the snap to the corners. Snap is only applied to parts like rectangle, panel, or rectangular shaped piece.





Additional information: the following information is displayed in the bar below the graphics area:

- X and Y coordinates of the cursor within the graphics area
- dimensions of the selected piece
- extra edges of the selected piece
- tool diameter

To confirm the creation or editing of the cluster press the **[Ok]** button, to cancel the creation or editing press the **[Cancel]** button.

## 2.3 Sheets

The **Sheets** page assigns the list of panels (sheets) on which the placements are to be carried out. It is possible to assign up to 100 rows.

ID	Progressive number automatically assigned, used as a unique identifier of the panel
ON	Select the box to enable the use of the panel. Select the header cell of column to change the box of all the rows in the table (if there are selected rows, only those will be changed).
Name	Identifier name assigned to the row The field may appear not editable or, if editable, it allows a direct assignment of a name to the element.
Length	Length of the panel
Height	Height of the panel
Thickness	Thickness of the panel
 Grain direction	Grain of the sheet The information on the (horizontal or vertical) grain is applied as a filter to check the correspondence with the pieces or the cluster: <ul style="list-style-type: none"> <li>a sheet with horizontal grain can place the pieces with vertical grain only if they can be rotated (90°)</li> <li>a sheet with vertical grain can place the pieces with horizontal grain only if they can be rotated (90°)</li> </ul>
 Available quantity	Available quantity of sheets: set a positive value ( $\geq 0$ ) not greater than 100. Select the header cell of the column to change the value of all the rows for the value of the current row.
 Quantity used	The column is managed automatically and shows the quantity actually used after the Nesting solution.
Material	Select the material of the panel (default selection: Generic).
 Colour	Select the colour of the panel Select the header cell of column to change the box of all the rows in the table (if there are selected rows, only those will be changed).
 Priority	Sheets with assigned priority (default value: 0; maximum value:100) take precedence in the nesting solution. How the priority value is interpreted is defined in the option Lower priority with increasing value in Nesting configuration.

## 2.4 Customizations

The page **Customize** sets and customizes the nesting procedure

Order Reference	This setting shows a reference to the customer and/or to order and or to the order number.
Product	This setting may show a reference to the product and/or model.
Unit	Unit of measure of the generated panels: [mm] or [inch]

	When placing TCN programs, all programs used must have the same unit of measure set here.
Tool diameter	Diameter of the tool for the execution of the cutting profiles: the field is set for information purposes and cannot be changed.
Margins	Node that groups together the assignment of the margins to apply. All fields assign a value $\geq 0$
Left Right Upper Lower	Waste margins of the panels
Internal	Distance summed with the diameter of the technology in order to determine the actual distance of the pieces placed.
Direction	Select the feed direction for the placements, choosing between the following available options: <ul style="list-style-type: none"> <li>• Horizontal (in the figure: cases on the left, horizontal red arrow)</li> <li>• Vertical (in the figure: cases on the right, vertical red arrow)</li> </ul> The choice represents the direction in which the sheets are filled: <ul style="list-style-type: none"> <li>• if the horizontal direction is selected, placements are made first in vertical direction;</li> <li>• if the vertical direction is selected, placements are made first in the horizontal direction.</li> </ul>
Starting vertex	Select the starting vertex for the placements, choosing between the following available options: <ul style="list-style-type: none"> <li>• Left-Lower (in the figure: cases on the first row)</li> <li>• Left-Upper (in the figure: cases on the second row)</li> <li>• Right-Lower (in the figure: on the third row)</li> <li>• Right-Upper (in the figure: on the fourth and last row)</li> </ul>
Apply priority of the pieces	Select to apply the priority values set for the pieces (TCN or rectangles). If the entry is not selected, or if all the panel types have the same priority, the pieces are used by ordering by height or length in descending order, based on the method chosen for the direction of the placements.
Apply priority of the sheets	Select to apply the priority values set for the panels. If the entry is not selected or if all the types of panel have the same programmed priority, the panels are used in the same order as in the list
Check material correspondence	Select to apply the material correspondence: a piece is placed only on one panel with the same material is set.

Check colour correspondence	Select to apply the colour correspondence: a piece is placed only on one panel with the same colour set.
Check thickness correspondence	Select to apply the thickness correspondence: a piece is placed only on one panel with the same thickness set. If the entry is not set, the single placements automatically take the panel thickness.
Apply original workings	Select to insert the workings of the original TCN programs in the panels of nesting. This selection is significant only in the case of <b>Panels (*.TCN)</b>
Minimize the rectangle of the overall dimension	Select to enable the search of the rotation that corresponds to the minimum overall dimension for the pieces that can be positioned. The selection is significant only in case of positioning of <b>Shaped workpieces</b> or <b>Nesting geometry</b> .

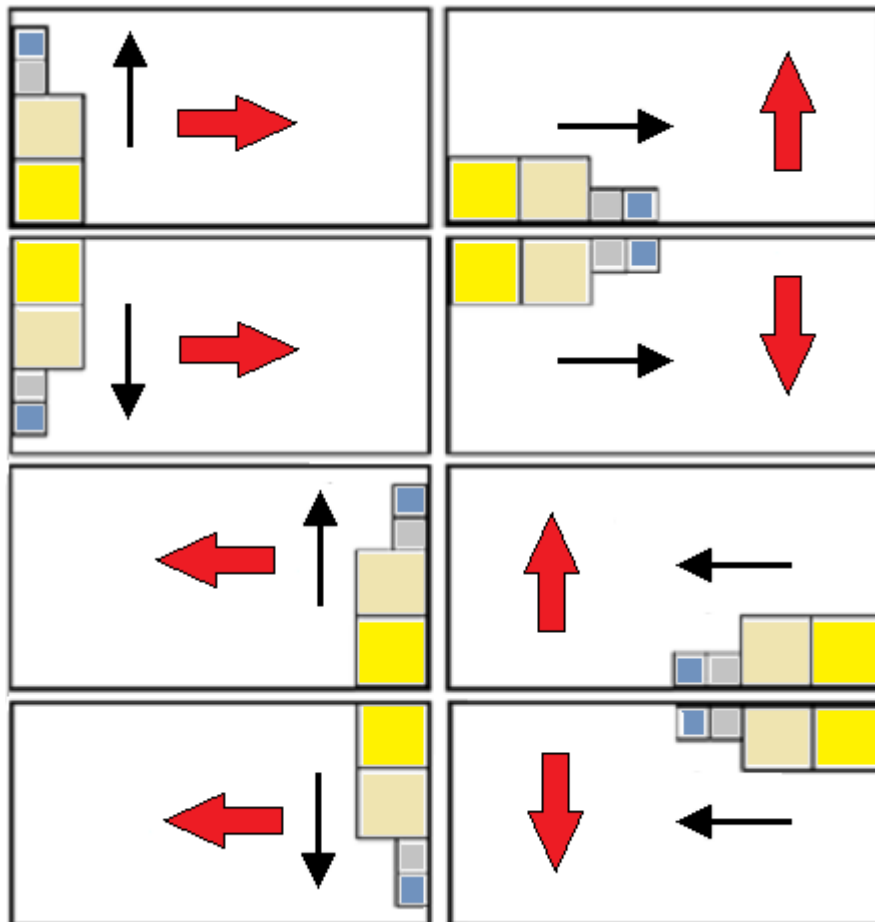
Figure related to: *Direction and Starting vertex*

### 3 Nesting solution procedure

Let us see how the menu is displayed, if just the operating level *Rectangular nesting* is available

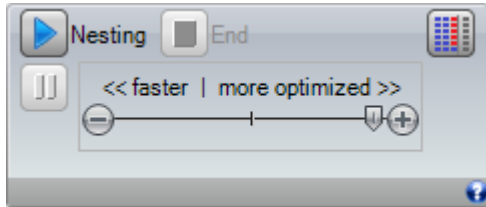

Select the **Nesting** button to start the optimization of nesting. Starting the procedure deletes each result already calculated, but not the files recorded for the previous results.



**End:** interrupts by canceling the calculation procedure



**Interrupt:** interrupts by closing the calculation procedure as soon as possible. The result that obtained by applying the shortest possible time, also at the expense of quality.

The << faster | more optimized (try more) >> scroll bar controls the optimization speed: more evaluations require a longer calculation time. The bar has four positions: from left to right, each one clusters a higher optimization level.

Let us see how the menu comes into view, if the operating level of *Nesting True Shape* is available

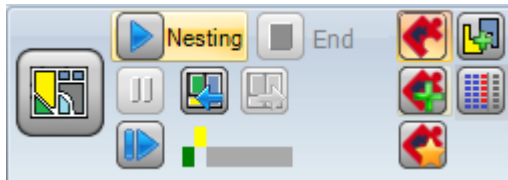

On the left side of the command group there is now a new command that can be activated (on/off) to select the active logic for the Nesting procedure:



Select the button to activate the *Nesting True Shape*

- if the list includes pieces like **Panel (\*.TCN)** and/or **Rectangles**, for these a procedure is performed to place the rectangles of overall dimension, each one calculated according to the dimensions of *Length* and *Height* assigned to the same pieces and with only possible rotation of 90°.
- In the following phase and for the remaining piece types a procedure of positioning through the application of *True Shape* is performed, to complete the sheets already partially occupied in the previous phase and/or to assign new sheets.

Deactivate the selection of this button to activate the *rectangular Nesting*



- an individual nesting procedure is performed, characterized by the positioning of rectangles of overall dimension of several pieces, each one calculated according to the type of pieces themselves.

The << faster | more optimized >> scroll bar is not visible and always applies the maximum value that corresponds to the most optimized solution.



**Restart:** it is selectable only in case of solution, that is partially or exclusively *True Shape* and with assignment of only one group of correspondence. This command requests to start the *True Shape* nesting

procedure, taking the last solution calculated as a starting point. You can then proceed to determine more solutions, up to a maximum of 10, and scroll through them choosing the one that you consider the best:



**Go to the next solution:**



**Go to the previous solution:**

both buttons allow to scroll and activate one the calculated solutions.

It is underlined that the determination of a new solution does not necessarily correspond to the criteria of the *the best solution* in absolute terms: it is the best solution calculated during the new calculation phase, but not necessarily better than the previous solutions.

In the event of a request to calculate a solution after the tenth, the first found in the list is discarded.

The possibility to request another solution as well can limit the 10 attempts: as a matter of fact, specific project evaluation may limit the effective calculation chance of a new solution.



The graphic check shows the status of the available solutions. Each solution is represented by a colored frame:

*yellow* for the current solution

*green* for each other valid solution

*grey* for a non-available solution.

The group of buttons on the right-hand side assigns some specific authorizations for the *Nesting True Shape* operation, applied to the project as a whole:



**Allow placements in the holes:** select to allow placements within the profiles marked as *Scraps geometries*, but only for pieces whose corresponding entry is in the selected column. If the selection is not active, no placement can be applied within the *Scraps geometries*, regardless the assignments in the project



**Place in the holes recursively:** select to allow recursive placements within the *Scrap geometries*.



**Prioritise placements in the holes:** the active selection activates the placements within *Scrap geometries*.



**Automatic clusters:** this selection enables the application of automatic clusters of pieces with respect to single positioning, but only for pieces that have a correspondent entry in selected column. For each piece in the list, the efficiency that can result from an automatic cluster is checked: a cluster that assigns an efficiency higher than or equal to the value set in the configuration (see chapter: ***Nesting configuration -> Nesting options***) determines an application of the privileged group with respect to the positioning of the single piece. Pieces of geometry corresponding to rectangles, circles, conic sections are excluded from application of automatic clusters.



**Grid placements:** this selection enables inserting placements according to a matrix layout, but only for those pieces that have the corresponding item in the column selected. The option can be used to generate homogeneous placements that follow a grid layout.

Grid-placement pieces are used before the others, and are placed in a row\*column order, considering the space available on the panel. In order to determine how to place it, each piece can be also analysed by applying independent cluster strategies, so to optimize the placement grid.

Grid placements executes the placement of pieces with a repetition of one unit, that can correspond to an individual piece always repeated with the same rotation, or two pieces with a reciprocal cluster defined with a 180° rotation. The repetition unit, be it an individual piece or two, can be placed considering a rotation variation of 0° or 90°.

Some buttons on the right side assign enabling operation to both types of nesting, *rectangular or True Shape*, applied overall to the project:



**Use the extra pieces only for filling:** the option concerns the placement of the assigned pieces in extra numbers (column headed as **Maximum quantity**). If the selection is not active, these pieces are used to fill the sheets already partially used with the required placements.

If the item is active, the pieces assigned in extra numbers are used only to fill the part in length or height already engaged with the required pieces.

This option is however applied only to the last sheet generated.

The filling direction is chosen according to the feed direction for the placements:

- if Horizontal: filling is applied to the length of the sheet, while no height limit is applied
- if Vertical: the filling is applied to the sheet height, while no length limit is applied.

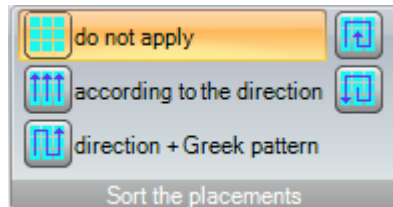

**Sort the placements:** a further group of buttons on the right side can change the type of sorting required for the placements on a sheet (see: **Nesting configuration -> Sorting logic**). In case of a solution already calculated, the change is directly applied.

At the end of the procedure you can access and store the results, if they are definitive.

Let us now examine in more detail the cases which may arise, based on how you have set the program to the Nesting section.

## 3.1 Correspondence groups

A correspondence group is the set of pieces and panels that can be grouped in a separate solution.

Nesting program can lead to identify multiple groups of correspondence as a result of the application of correspondence filters.

Specifically: material, colour, thickness.

The assignment of the grain is not a primary matching filter: pieces with the same grain can thus be used in different correspondence groups.

If multiple groups of correspondence are identified an *independent solution* runs for each group.

In the following paragraphs,

*single piece or multiple piece,*

*single panel or multiple panel*

*best solution*

*Step-by-step solution*

are always to be interpreted as associated with a single correspondence group.



## 3.2 Multiple pieces and multiple panels

Both the piece list and the panel list have more than one line enabled:

- if there are no manual clusters in the piece list, the **Available quantity** both of the pieces and the panels must be strictly positive ( $>0$ ).
- if there is at least one manual cluster in the piece list, **all** pieces used in the same cluster may have Available quantity  $>0$ . This way the procedure uses the number of pieces needed to meet the cluster demand and places the remaining pieces individually.
- if there is at least one manual cluster in the piece list, **all** pieces used in the same cluster may have Available quantity  $=0$ . This way the nesting procedure places the number of pieces needed to meet the cluster demand.

The procedure places the pieces onto the fewest panels available. If the procedure has positioned the available quantity of parts and a **Maximum quantity**  $>$  **Available quantity** is set for some of them, the placement fills the panels already used up to the maximum limit, up to the maximum value set.

## 3.3 Single piece and single panel

One line only is enabled in both the list of the pieces and the list of the panels. According to the needs, you can select from specific optimizations:

- Available quantity of the pieces  $=0$ , Available quantity of the panels $=0$ : the procedure places the greatest number of pieces on 1 panel.
- Available quantity of the pieces  $=0$ , Available quantity of the panels $>0$ : the procedure places the greatest number of pieces on the number of the available panels.
- Available quantity of the pieces  $>0$ , Available quantity of the panels $=0$ : the procedure calculates the number of the panels needed for placing the number of the pieces. If a Maximum quantity $>$ Available quantity is set for the piece, the positioning fills the panel up to the maximum limit, up to the maximum value set, reaching the maximum value set.
- Available quantity of the pieces  $>0$  Available quantity of the panels $>0$ : the procedure places the number of pieces on the lowest number of the available panels. If the procedure has positioned the available quantity and if for some of them a Maximum quantity $>$  Available quantity is set, the positioning fills up to the maximum limit the panels already used, up to the maximum value set.
- Available quantity of the pieces  $=0$  and the part is used in a cluster, the procedure places the number of pieces required to meet the cluster's request.
- Available quantity of the pieces  $>0$  and the part is used in a cluster, the procedure uses the number of pieces required to meet the cluster's request and places the remaining pieces individually.

## 3.4 Multiple pieces and single panel

The piece list has more than one line enabled, while the panel list has only one line enabled.

Depending on your needs it is possible to select from specific optimizations:

- if there are no manual clusters in the piece list, the **Available quantity** of pieces must be strictly positive ( $>0$ ).
- if there is at least one manual cluster in the piece list, **all** pieces used in the same cluster may have Available quantity  $>0$ . This way the procedure uses the number of pieces needed to meet the cluster demand and places the remaining pieces individually.
- if there is at least one manual cluster in the piece list, **all** pieces used in the same cluster may have Available quantity  $=0$ . This way the nesting procedure places the number of pieces needed to meet the cluster demand.
- Available quantity of the panels  $=0$ : the procedure calculates the number of the panels needed for placing the total number of the pieces.
- Available quantity of the panels  $>0$ : the procedure places the number of pieces on the lowest number of the available panels.

In both cases: if the procedure has positioned the available quantity of the pieces and for some of them a Maximum quantity $>$  Available quantity is set, the placement fills up to the maximum limit the panels already used, up to the maximum value set.

### 3.5 Single piece and multiple panels

The piece list contains one enabled line only, while the panel list has more than one line enabled. The *Available quantity* of panels must absolutely be a positive value ( $> 0$ ).

According to the user's needs, it is possible to choose among specific optimizations:

- Available quantity of pieces = 0: the process places as many pieces as possible in the available panels
- Available quantity of pieces  $> 0$ : the process places that quantity of pieces on as few available panels as possible. If the process placed the available quantity and for the piece Maximum quantity  $>$  Available quantity is set, the placement fills up the last panel that was already used, up until the last maximum set value.
- Available quantity of the pieces  $=0$  and the part is used in a cluster, the procedure places the number of pieces required to meet the cluster's request in the available panels.
- Available quantity of the pieces  $>0$  and the part is used in a cluster, the procedure uses the number of pieces required to meet the cluster's request and places the remaining pieces individually on the lowest number of available panels.

### 3.6 Applied criteria and filters

The Nesting procedure applies evaluations and filters, some of them are fix and other are variable according to the settings of the project. The filters are referred to:

Material for the panels	If the selection of <b>Check material correspondence</b> is active: only the pieces with the same selected material are placed on the panel.
Colour of the panels	If the selection of <b>Check colour correspondence</b> is active: only the pieces with the same selected colour are placed on the panel.
Thickness of the panels	If the selection of <b>Check thickness correspondence</b> is active: only the pieces with the same assigned thickness are placed.  A particular situation is associated with the case of sheets assigned with different thickness: in this case the activation of the item <b>Check thickness correspondence</b> is required.
Grain of the panels	Only pieces which check the correspondence of the grain are placed on a panel, possibly applying a 90° rotation.  In the event that a piece can be placed in different sheets, a privileged positioning in the sheet with the same assigned grain is not guaranteed.

Evaluations relate to:

Number of required positionings	The total number of the required positionings is limited to 10000.
Priority of the pieces	If the selection of <b>Apply priority of the pieces</b> is active: the placement of the pieces privileges those that assign a priority value, which is interpreted based on how the flag Lower priority with increasing value is set in Nesting configuration.

Apply priority of the sheets	If the selection of <b>Apply priority of the sheets</b> is active: the use of the available panels privileges those that assign a priority value, which is interpreted based on how the flag Lower priority with increasing value is set in Nesting configuration.
Criterion for sorting the pieces.	As for <i>rectangular Nesting</i> only the selection is made at the configuration level and, combined with the previous selections, contributes to the definition of how to prepare the list of pieces which will be placed.  Four options are available for the selection and the choice is made according to the specific production requirements (see chapter: <b>Nesting configuration-&gt;Nesting options</b> )

The limit situation that all the evaluations deriving from the application of filters can determine is the impossibility of producing a result: in this case you will need to change some settings and/or activations, in order to produce usable results.

## 3.7 Best solution

The procedure of Nesting is inherently a recursive optimization procedure, which aims to determine the "*best result*": in some cases, it can be rated as an excellent result, in others only as a good result, since the best result ever does not generally exist.

The way to get the result of nesting is to perform a set of different nesting cycles, changing some choices in procedures, in order to obtain different solutions.

We reaffirm that the set of filters and selections indicated in the preceding paragraph shall determine the preconditions for the implementation of the various cycles of nesting, affecting from the beginning the obtainable solutions.

The selection of **Criterion for sorting the pieces**, combined with to the status of the scroll bar << faster | max.

<< (faster) | more optimized (try more) >>

conditions also the number of the calculation cycles. Because every cycle is characterized by different choices, such a cycle corresponds to a different kind of procedure.

The comparison between the solutions leads to choose that found to be the best one.

The iterative procedure is performed in succession to each sheet, in order as required by various selections, up to total positioning of the pieces or to the total use of the sheets.

As a last point we want to define what determines the choice between two different solutions for a particular sheet. We can examine some of the points generally applied when determining a *Rectangular nesting*:

- the greatest area of placements is preferred. A solution providing pieces that occupy the 93.0% of the sheets is better than one determining a filling of the 88.00%. In the case of equal amount of occupied area:
- it is privileged the solution that gives priority to the positioning according to the selected direction: along the Y axis in the case of Horizontal direction, along the X axis in the case of Vertical direction. In the case of equal positioning:
- it is privileged the "most ordered" solution (the valuation is based on the comparison of the off-cuts within the overall rectangle of the placed pieces). If no choice is possible:
- additional evaluation criteria are applied to the grid of the piece disposition, as well as to the number and sizes of the placed pieces and of the internal off-cuts.

Each above-mentioned point:

1. is applied with a relevance that varies according to the configuration options related to the comparison of solutions (see: Nesting configuration)
2. is applied with one or more margins of tolerance, partly fixed and partly adapted to the specific project of nesting, in order to allow the combined evaluation of the largest number of solutions. An example: the comparison between the areas of placements is not absolute (92.7<93.0), but it applies the dimension.

This is only the comprehensive framework within which the theme is developed. It particularly concerns the cases of *Rectangular nesting*. The solution of *Nesting True Shape* modifies this framework in such a significant way that it requires changes to all the evaluations made so far.

## Solution of Rectangular nesting

Pieces like **Panel (\*.TCN)** and/or **Rectangles** are anyhow processed according to a specific logic of rectangular nesting:

- the positioning of each piece considers the only rectangle of overall dimension calculated according to the dimensions of *Length* and *Height* assigned to the piece itself;
- in the case of **Panel (\*.TCN)**, the real overall rectangle can be modified for workings outside the piece;
- the positioning of each piece can apply a counterclockwise 90° rotation.

It is possible to apply the same logic even to the remaining types of piece **Shaped workpieces** and/or **Nesting geometry**, but with some variations that we here can refer to:

- the positioning of each piece now considers the rectangle of overall dimension of the only profile characterized by *Nesting geometry*
- the initial positioning of the pieces can be previously modified with respect to the original program, with rotation assigned so as to minimize its rectangle of overall dimension. This can be done if the workpiece assigns "any" or 90° rotation, but keeping the item *Minimize the overall rectangle* active.
- the real positioning of each piece can apply a counterclockwise 90° rotation.

*The nesting procedure is such as to lead to the definition of a solution that can be determined in a repetitive manner, keeping all settings of the contour unchanged: they could influence its development. The time necessary to determine the solution is normally reasonable and, as such, it is not limited in advance.*

## Solution of Nesting True shape

Pieces like **Shaped workpieces** and/or **Nesting geometry** can be processed according to a specific logic *True Shape*:

- the positioning of each piece now considers the form of the profile characterized by *Nesting geometry*
- the positioning of each piece can apply different rotations, that can be defined with steps lower or equal to 90°
- it is possible to realize placements in the scrap areas within a piece and defined by *Scrap geometry*.

All that is described in the previous paragraph to determine the *Best solution*, it is totally valid for a rectangular solution, but it is certainly less valid in the case of a True Shape solution.

The problem is made considerably more complex from the fact that the positioning concerns *free, concave or convex forms with internal holes that can be used in number and the possibility to rotate variables*. The joint possibility among forms is nearly endless. The figure proposes 5 different shapes of pure invention

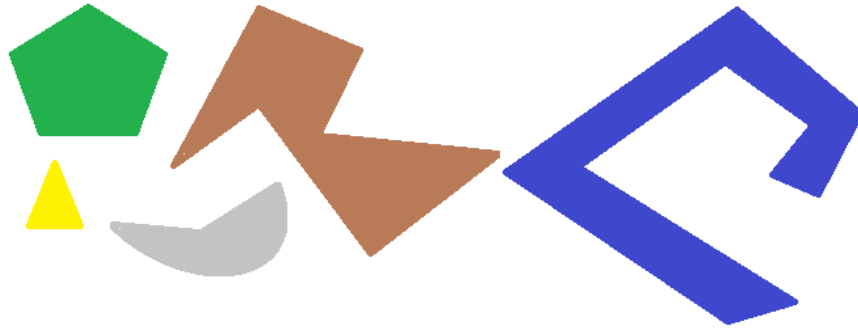

It is clear that the *simple* problem of positioning a single form for type, with a possible step-by-step 90° rotation and occupying the smaller and more compact area, is not that simple: each form has 4 possible solutions of positioning (0°, 90°, 180°, 270°) and each one must be evaluated for each possible positioning of the remaining figures and for each possible combination of approach.

We now assign a number of repetitions for each form (let's assume 10): each repetition of a form must be evaluated with any other repetition of placeable form, for a total number of 50 forms.

We now assign an angular step of 45°: each form has now 8 possible solutions of positioning (0°, 45°, 90°, ..., 315°)

It is clear that the problem is not that simple.

It is universally recognized that the theoretical solution to a problem of this kind cannot be entrusted to the only reasoning, but it is necessary to rely even on the case.

*One consequence of this is that there can be no guarantee that the solution will be proposed in a repetitive manner. Another consequence is that there is always the possibility that one new attempt can improve a solution: this is why it is necessary to set a time limit.*

*The Nesting True Shape procedure implemented here, however, is such as to cancel out the random component, by making appropriate choices such as to determine solutions in a repetitive manner. The only variable part is therefore the time available: a longer calculation time can allow more solutions to be calculated and compared, and ultimately a better solution.*

As already for the placement of rectangles, the selection criteria of a solution concern the occupation, the compactness of the area and the area of placements. On the contrary, the possibility of applying criteria regarding the order in the layout of the individual pieces is excluded.

As previously stated, the selection of the button  requires a new nesting optimization, and the elimination of every previously calculated result. In this case, processing with a *True Shape* logic returns the best calculated solution, based on the maximum time assigned.

It is possible to obtain more solutions by selecting the button : in this case, the calculation process can start the calculation of several solutions, then the process will be stopped according to the maximum allotted time.

### 3.8 Step-by-step solution (Rectangular Nesting)

In determining the solution of an exclusively rectangular nesting you can activate a step by step procedure, which allows the operator to choose his own best solution.

Let us see in summary what that is.

You must still perform a first fully automatic nesting: let us take again the example already proposed solution corresponding to two panels, as shown in the tree structure of the next chapter.

The solution of each panel is the result of previous discarded solutions:

- the first solution found corresponds to the limit: this is the first choice
- more generally, it corresponds to a following choice, for example the third one.

This information is given in the node matching the panel, as **Solution number** (example: 1 or 3):

- if 1, you cannot require a step-by-step solution for the panel.

It is assumed that the solution of automatic nesting is **Solution number**:

- 3 for the first sheet
- 1 for the second sheet.

A. Take a position on the first node of the first sheet and require a nesting solution. A window appears, as follows:

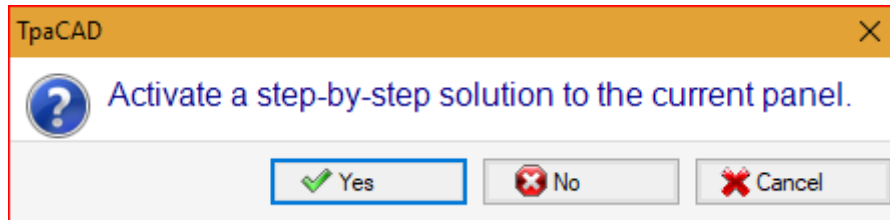

A. To confirm, select **Yes**

The procedure of Nesting starts requiring:

- for the first sheet the choice of the first solution found
- for the following sheets, the procedure is carried out without constraints.

The nesting solution now shows

- **Step-by-step solution** =1, for the first sheet
- **Solution number** =1 or greater for the second sheet.

Now it is possible

1. to apply for an advancement of the step-by-step solution for the first sheet, choosing the second of the original three solutions found. To do it:
  - keep the selection on the node of the first sheet;
  - apply again for a nesting solution and confirm the new window on **Switch to the next solution of the current panel**;
  - at the end, value the situation from the beginning;
2. to keep valid the solution found for the first sheet and activate a step-by-step solution for the second sheet (only if the **Solution number** is greater than 1). To do it:
  - move the selection to the node of the second sheet,
  - apply again for a nesting solution and confirm the new window on **Switch to the next solution of the current panel**;
  - at the end, value the situation from the beginning;
3. to reset to the nesting automatic solution. To do it:
  - apply again for a nesting solution and confirm the new window on **Delete all**;
  - at the end, value the situation from the beginning;
4. keep valid the overall solution found and save the results of the Nesting.

As you can see, the step-by-step procedure:

- is activated for the solution of each individual sheet;
- influences the solution of the following sheets;
- is independent for each group of correspondence.

## 4 Nesting results

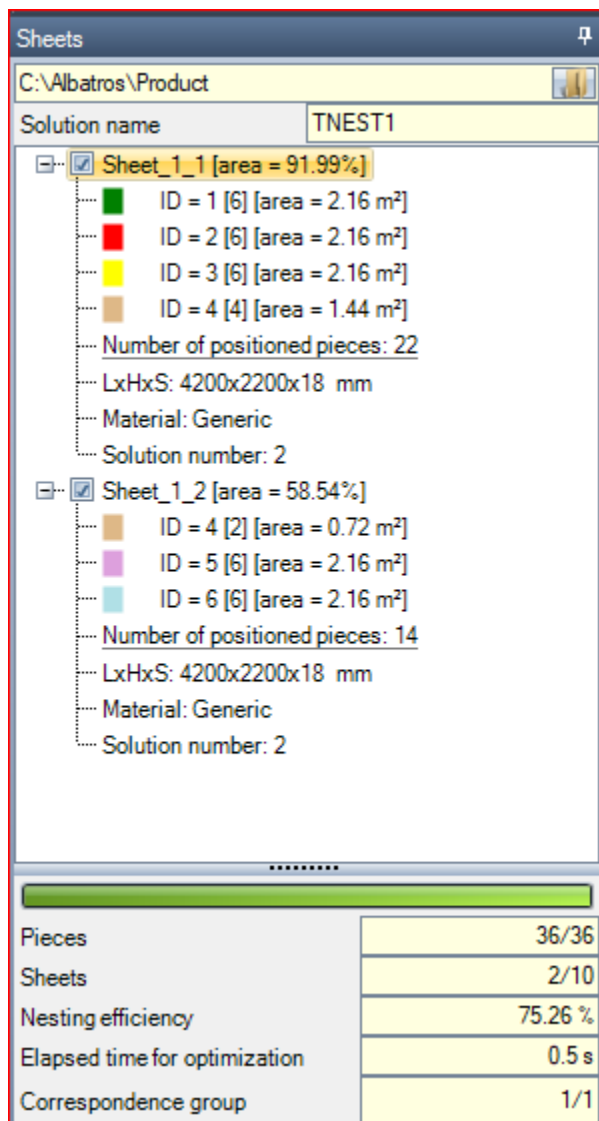

At the end of the *Nesting* process you can see the results. **WARNING:** The nesting solution does not cause the automatic storage of the results.

Continuing with the already mentioned example, the solution corresponds to two panels, both of the same type, as shown in the tree structure in the figure:



- each main node corresponds to a panel, indicated by the name "Sheet\_(id)\_(item)" where:
  - (Sheet) the name prefix is always assigned automatically
  - (id) is the unique ID of the panel (here: 1)
  - (item) is the progressive number of the panel (here: (1, 2)).
- each panel reports the percentage of the useful area occupied by the positioned pieces: the useful area of the panel excludes the outer edges, while the area of a positioning includes the area of the piece (length \* height, or the shape area) but not the internal edge set for the project and the overall dimension of the cutting routes.
- the expansions of a main node correspond to the types of the pieces applied
  - colour and ID correspond to the line of the piece in the Nesting section
  - the numbers in square brackets show the quantity used for the panel.

Each main node has an enabling box:

- the box is assigned as not selected (and cannot be changed), if the panel shows some errors. A typical error situation is, for instance, the result of the rotation of a piece that programs a SAWING WORK;
- without an error report, the selection can be disabled manually.

Only panels that correspond to enabled nodes are useful for the solution.

Error or warning situations are highlighted by an icon on the node:

-  in case of an error
-  in case of a warning.

The selected node corresponds to the panel represented in the graphic area.

If the solution has identified several Groups of correspondence, a grey line separates the nodes in a group from the next.

The lower part of the area displays the complete information about the nesting solution:

- The number of placed pieces on the requested total, with details on the number of potential extra placements
- The number of panels used on the available total
- The total efficiency of the nesting, calculated as ratio between the area used for the placements and the total area of the used panels. If the solution creates more sheets, the efficiency evaluation can be differentiated for the last sheet, that can only be partially used. The evaluation does not calculate the islands useful for the placements: this means that they are considered as used areas.

## 4.1 Error situations

Particular situations, usually divided into three categories (errors, serious warnings and reports) can be diagnosed for a panel.

If an error occurs, the panel is excluded from the solution.

Cases of **error**:

- compilation errors of the TCN program, independent from the nesting procedure (example: use of an invalid working);
- request for mirror application.

Cases of **serious warnings**:

- all serious WARNING situations (while running they become ERRORS);
- error due to the application of Tool compensation.

*Serious warnings*, if not otherwise removed later, determine in fact the impossibility to the execution of the panel.

Errors can be diagnosed for the cluster. In addition to the error, the ID of the cluster and/or the ID of the piece whose data gave rise to the error can be displayed. Below are only the errors that may be due to different situations:

### Error assigning manual cluster

- fewer than two parts were placed in the cluster
- the thickness of the cluster is not equal to that of the parts
- a part has been entered rotated into the cluster, but cannot be rotated
- a part has been entered speculated into the cluster, but cannot be speculated
- there are not enough pieces to nest the requested cluster





### Certain requirements for matching cluster and parts are not verified

- the matching group of the cluster parts must match the matching group of the cluster. The verification is performed if **Check the correspondence between cluster and pieces** flag is enabled in the Nesting configuration
- pieces with different grains are inserted in the cluster
- pieces with different thickness are inserted in the cluster







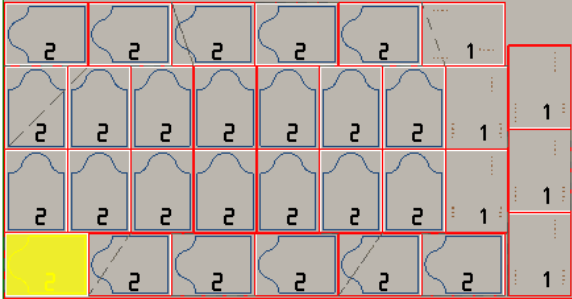

## 4.2 Representation of the panels

The representation of the panels is standardized and targets the Nesting functionality.



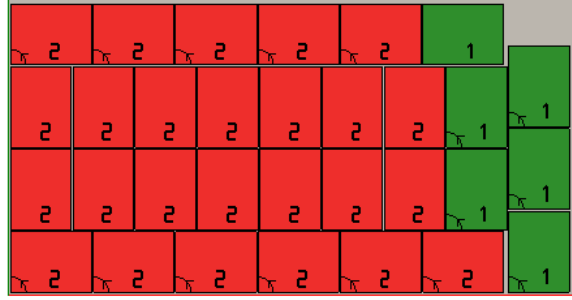

The graphic representation of the current panel is determined by the options selected in the menu. The figures below show the remarkable number of cases (for a project of rectangular nesting):

	<ul style="list-style-type: none"> <li>•  <b>View areas:</b> OFF</li> <li>•  <b>Cutting profiles:</b> OFF</li> <li>•  <b>Identify the pieces:</b> ON</li> <li>•  <b>Labels:</b> ON</li> </ul> <p>For each piece following items are represented:</p> <ul style="list-style-type: none"> <li>• overall rectangle;</li> </ul>
--	---



	<ul style="list-style-type: none"> <li>• the associated workings (in the event of TCN program only);</li> <li>• Identifier number (ID) of the piece;</li> <li>• Representation of the <i>Label-BARCODE</i> working (programmed or added in the TCN).</li> </ul>
	<ul style="list-style-type: none"> <li>•  <b>View areas:</b> OFF</li> <li>•  <b>Cutting profiles:</b> ON</li> <li>•  <b>Identify the pieces:</b> ON</li> <li>•  <b>Labels:</b> OFF</li> </ul> <p>The cut paths are added to the previous case: the red colour of the lines indicates the programming with feed-through depth.</p> <p>The figure highlights the current working on the positioning left below) Click on a positioning to move the current working:</p> <ul style="list-style-type: none"> <li>• on the status bar the geometric information on the positioning are displayed.</li> </ul>
	<ul style="list-style-type: none"> <li>•  <b>View areas:</b> ON</li> <li>•  <b>Identify the pieces:</b> ON</li> <li>•  <b>Labels:</b> OFF</li> </ul> <p>For each piece, now it is represented:</p> <ul style="list-style-type: none"> <li>• the overall rectangle filled with the colour associated with the piece (the same colour in the sub-node for the piece typology);</li> <li>• accessory graphics to indicate the rotated and/or mirrored positioning of the piece (in the picture: the indications are related to some pieces rotated to both typologies);</li> <li>• the Identifier number (ID) of the piece.</li> </ul> <p>The selection relating to the <b>Cutting profiles</b> is irrelevant</p>
	<p>The picture corresponds to a case of set edges.</p> <p>The assigned edges are represented for each piece, with application of the rotated and/or mirrored placement options: a dotted line placed in correspondance of a side of the piece shows the presence of the edge.</p>

#4	#8	#12	#16	#22	#26			
#3	#7	#11	#15	#21	#25	#29		
#2	#6	#10	#14	#18	#20	#24	#28	#31
#1	#5	#9	#13	#17	#19	#23	#27	#30

-  **View areas:** ON
-  **Identify the pieces:** OFF
-  **Consecutive numbers of the pieces:** ON
-  **Labels:** OFF

The representation is similar to the previous one, and changes the meaning of the numbering on the individual placements (example: "#12"):

- now the numbering is unique on the panel and corresponds to the consecutive numbers of the placements.

The option **Consecutive numbers of the pieces** is available in the menu, if the optimization is not applied while creating the labels (see chapter: *Nesting configuration*). In this case for each single positioning, a file corresponding to the label to be applied to the piece is created and recorded and the same label may include the information of the *consecutive number of the piece*, as well as the graphic information of the positioning itself on the sheet.

The selections **Consecutive numbers of the pieces** and **Identify the pieces** are mutually alternative: the selection of one of those automatically disables the other.

The graphical representation of each panel applies (in order of priority):

- the pattern matching the selected material, or
- the colour assigned to the panel itself, or
- the pattern or colour assigned in the prototype of the nesting panels.

The graphical representation is kept flat, and the interactive rotation commands of the piece are disabled. If the *Nesting-flip* functionality is active: it is also possible to activate the view on face 2 (bottom).

La tabulation of the **View on** menu remains active and it is possible to customize the view. More specifically, it is possible to:

- apply tool compensation;
- change the selections of the overall dimensions.

The graphical representation of the applied workings *excludes* the display of particular visual elements, such as:

- arrows of profiles and extreme points on the segments
- 3D graphic overall dimensions
- original profiles in compensation.

## Solution (EXAMPLE #1)

The figure can correspond to a more complete case, through the application of different piece types. The panel can correspond to a completely rectangular or mixed solution:

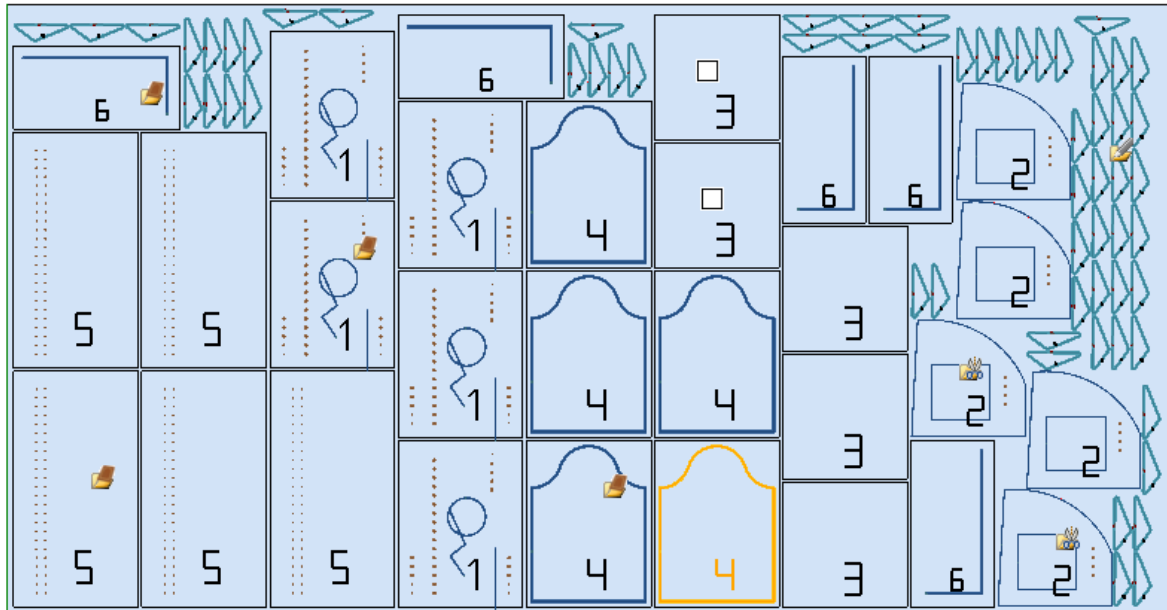

On different positionings it has been positioned the icon that corresponds to the type during the project of nesting:

- ID=1, 4, 5, 6 correspond to **Panels (\*.TCN)**
- ID=3 correspond to **Rectangles**
- ID=2 correspond to **Shaped workpiece** (evident from the presence of workings in drillings)
- ID=7 correspond to **Nesting geometry** (a type of **Shaped workpiece** could also be possible).

In the figure no use of scrap area results and for all the pieces the possibility to rotate by 90° has been enabled. In case of mixed solution, we must consider the extra positionings of the pieces interested to the rectangular solution: these pieces are anyhow placed before the placements True Shape and they can increase the real number of the sheets used.

## Solution (EXAMPLE #2)

The image offers a solution complete with shapes, again with the enabled possibility to rotate with 90° steps:

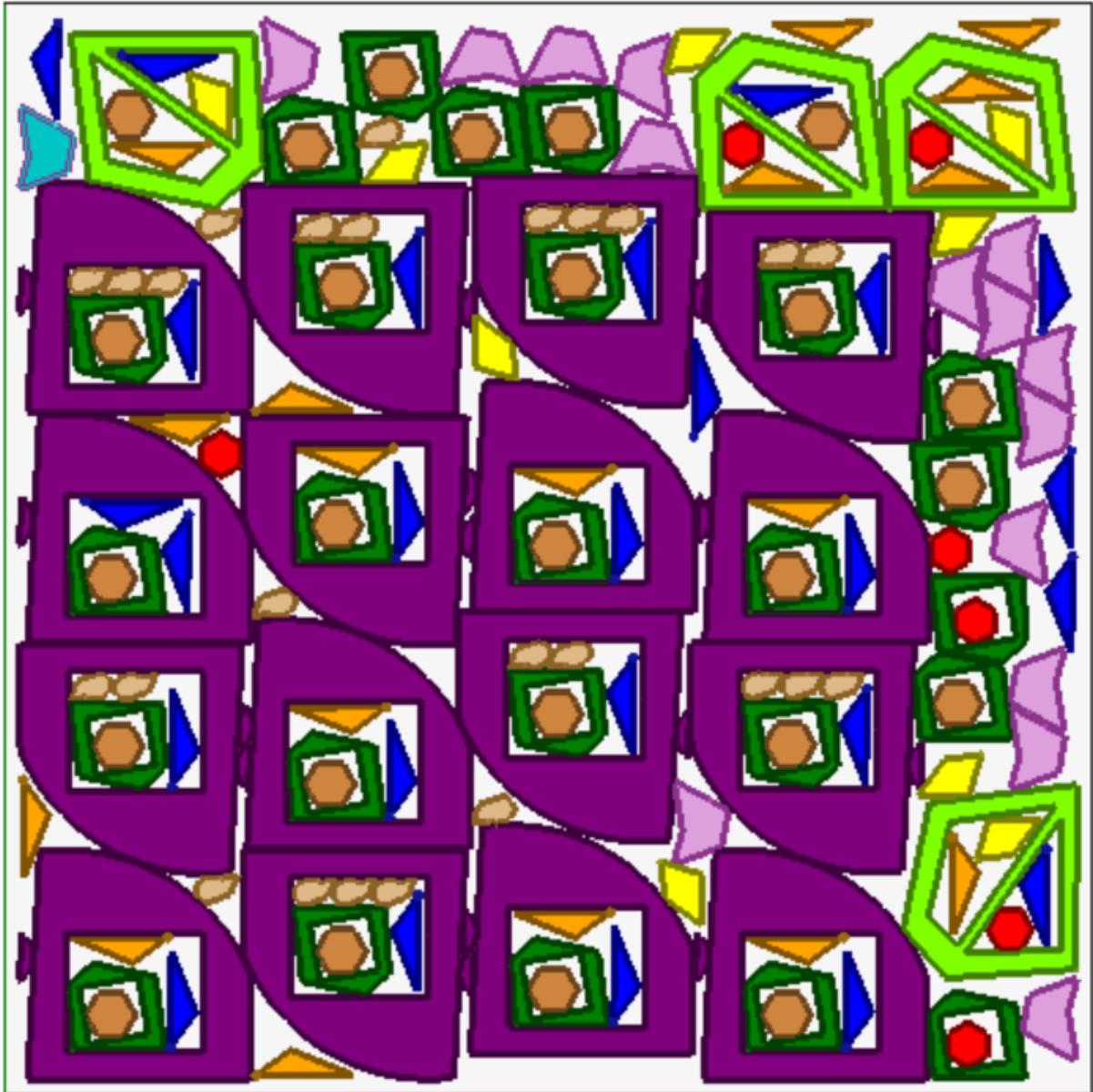

Each piece is represented with its associated area colour, and this shows clearly how scrap areas are used, even with recursive positionings.

### **Solution (EXAMPLE #3)**

This solution corresponds to a case of rectangular Nesting solution, with the evaluation of additional overall dimensions.

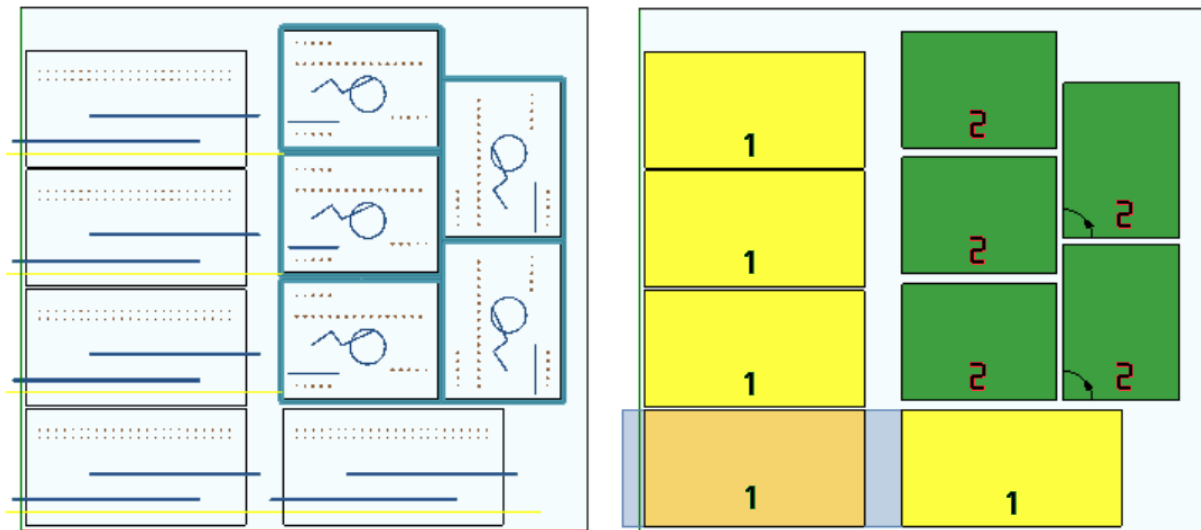

- on the left the pieces with the applied workings are represented
- on the right the option **View areas** is selected.

The solution corresponds to the positioning of two types of piece, both needing for positioning outside the size of the piece:

1. these two types of pieces come out from the milling and sawing workings, all in X direction. The right representation shows the current working on the first positioning of the piece: the external area, shown in light grey, highlights the overall dimensions added in the horizontal direction, whose entity is greater on the right side;
2. contouring profile, which presumably performs the direct cutting of the piece. In this case, the added dimensions are symmetrical on the four sides of the piece.

Please, note how the added overall dimensions assign areas considered to be waste:

- contiguous overall dimensions added are overlapping
- placements are forbidden in all the overall dimensions added.

The evaluation of additional overall dimensions is only applied to the rectangular Nesting solution.

## Solution (EXAMPLE #4)

This solution corresponds to a case of Nesting True Shape solution, with grid placements applied.

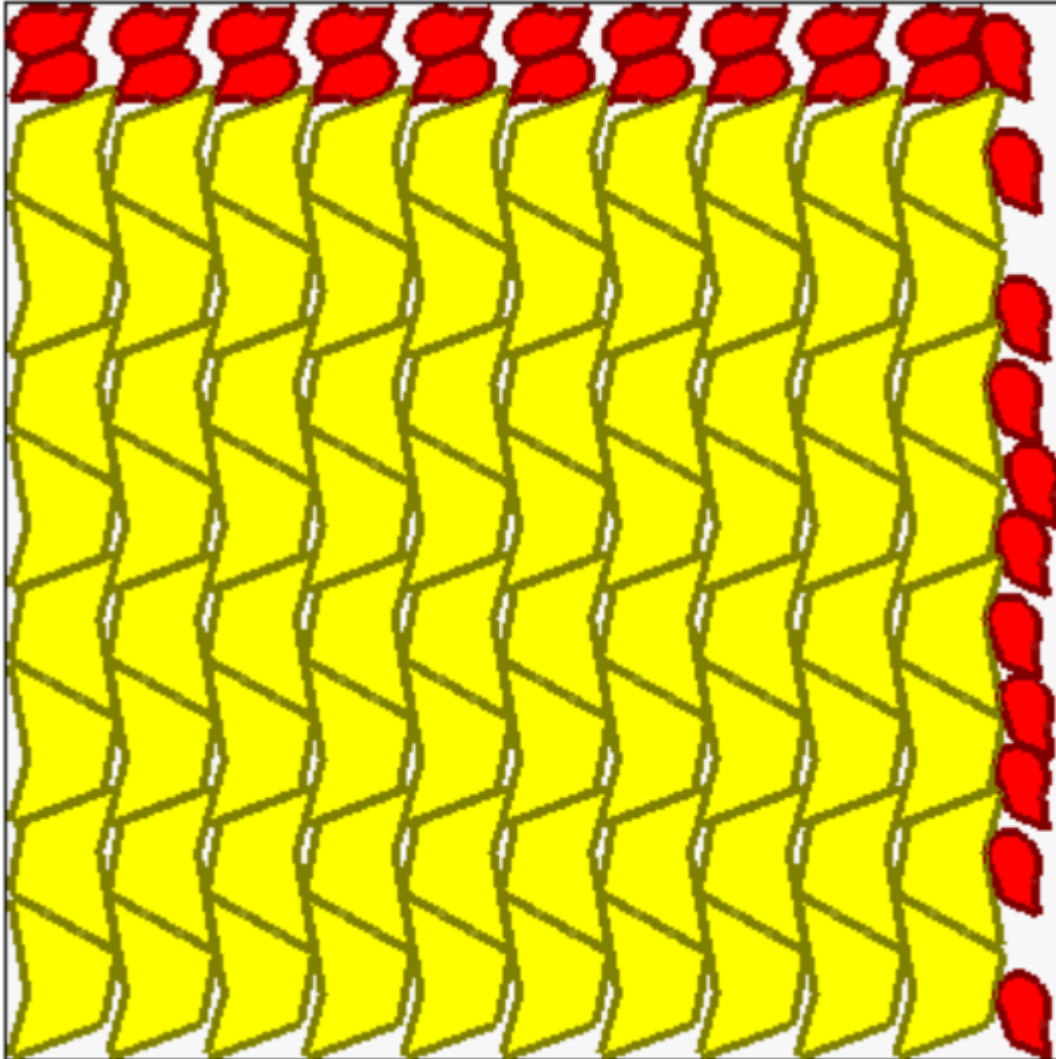

The pieces represented in yellow require a *Grid placement*.  
The pieces represented in red may require *Automatic clusters*.

It is clear how the grid placement places the (yellow) pieces with a repetition of one unit corresponding to an *automatic cluster*: an individual placement corresponds to two pieces in a reciprocal cluster defined with a 180° rotation.

The placement of red pieces is compliant to the request of *automatic cluster* on the top of the panel, while on the right side the available placements are more scattered and separated.

## 4.3 Cutting paths

The cutting paths are automatically inserted for pieces of **Panels (\*.TCN)** and **Rectangles** types and can be separated in a path with a rectangular development around each piece, or optimized in only one path according to the **Nesting configuration**.

Optimization consists in performing a single cutting profile with a maximum reduction in direction changes and deletion of the repeated segments. Cut segments geometrically separated are connected with movements performed in the air, over the piece or through a rapid movement.

The paths are represented in a custom colour.

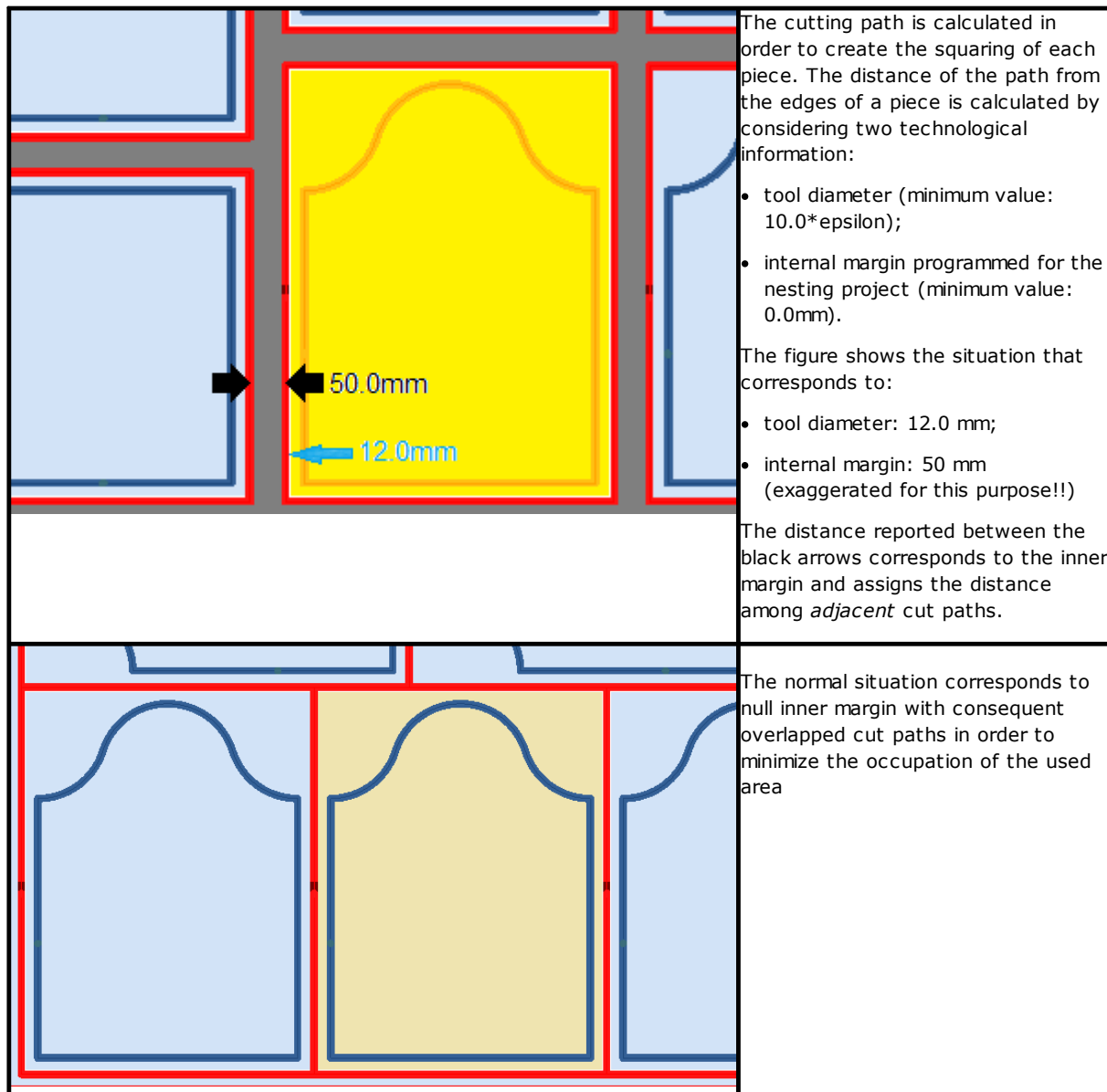

The cutting paths that are added by the Nesting procedure concern the types of pieces **Panel (\*.TCN)** and **Rectangle** only and, in the first case, just the cases where the option of adding cuts is selected.

The cutting path(s) is (are) inserted at the end of the workings.

The piece cutting can be performed with multiple options:

- differentiated into a pre-cut profile and a following cutting profile
- the entry up to the pre-cut depth (or cut) can take place with subsequent feeds
- the entry at the final cutting depth can apply bridges, so that the part does not become completely detached from the sheet.

Similar considerations can be made for the shape cutting profiles, with some variations:

- the profiles are assigned into the original programs
- it is not possible to modify them by applying an optimization logic: each profile remains separate
- any modifications are applied directly to the original profiles (pre-cut, depth feeds, application of bridges).

## 4.4 Cut of the scraps

The cuts of the scraps are generally treated as cut path(s), to facilitate the removal of the parts of the panels not used to place the pieces.

The cutting profiles of the scraps can be inserted in case of panels *only* applying **Panel (\*.TCN)** and **Rectangle** piece types.

These elements are also automatically inserted under a specific activation.

Cut profiles of the scraps are inserted in the queue to other workings, the technology used is the same of the cut profiles of the piece and each individual segment assigns a profile.

The fragmentation of the scraps values the dimensions of the parts without placements, positioned along both the sides of the panel opposite the starting vertex of the placements. The figure shows a panel where the residual area is highlighted in green (above and on the right):

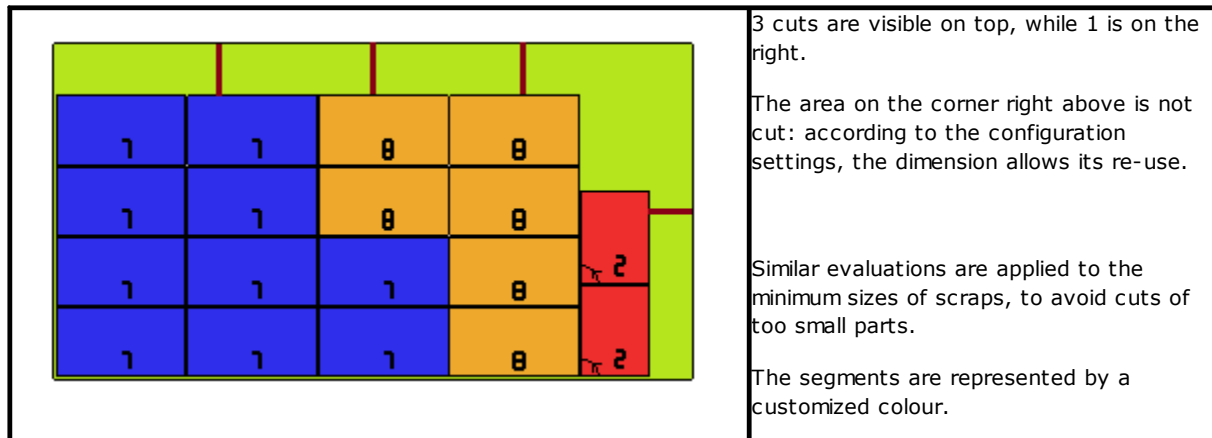

## 4.5 Labels

The label management is also conditioned by a specific activation.

In the case of nesting of TCN pieces, the same programs may already have scheduled a **Label-BARCODE** working, as defined in TpaCAD environment. If the label has not already been programmed, or in the case of rectangle nesting, the working is automatically inserted in the center of the piece, but only if its dimensions are smaller than the dimensions of the piece. The working is not inserted anyhow in case of **Shaped workpiece** or **Nesting geometry**.

The working of labels, which is available in the TpaCAD environment, may show some changes, compared to the basic working and according to the specific needs of a product application.

In case of multiple schedules of the **Label-BARCODE** working, only the first one is considered.

The **Label-BARCODE** are completed by adding some information:

- File search path to save the label associated with each individual positioning: this is an image file, of managed extensions (\*.jpg; \*.png; \*.bmp). The files of the labels are created during the execution of the **Save the results** command;
- specifications of placing: positions of the label application (assigned in case of automatic insertion), rotation and mirror (as assigned by the procedure of nesting).

The **Label-BARCODE** programmed workings may be interpreted during the execution of the nesting panels, for the automatic printing of the labels and their following application on the single pieces cut from the nesting panels.

The format of the labels and the include information are defined at the level of **Nesting configuration**.

The creation of the files for the labels can be optimized, i.e. only different labels are created, or you can record a file for each positioning. The method of operation is determined during the *Nesting configuration*.



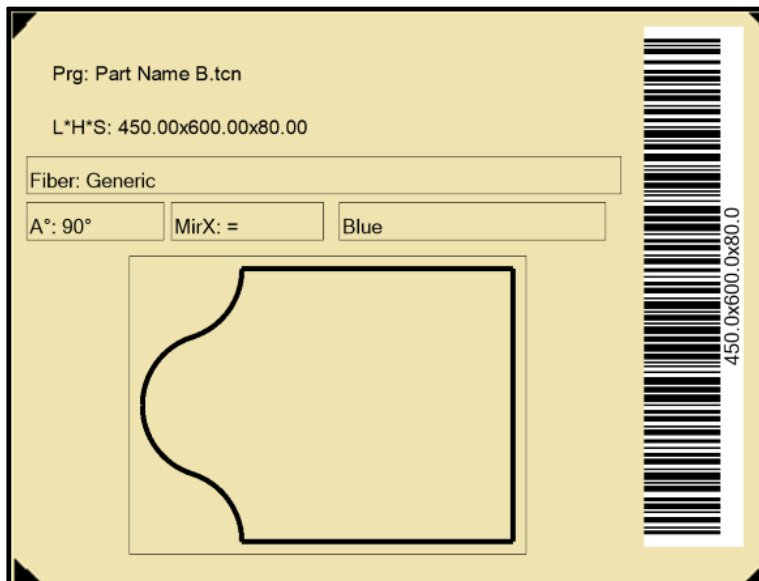

The image shows an example of a label generated by an **optimized** procedure. The image shows the following information:

- *program name*: in this case "b" (field title: "Part Name")
- *single dimensions* of the positioning: "L" (length), "H" (height), "S" (thickness)
- *dimensions* as one (LxHxS in the barcode)
- *material of the sheet*: in this case "Generic" (field title: "Fiber")
- *transforms* of the positioning: rotation and mirror ("A°", "MirX")
- *colour of the sheet*: in this case "Blue"
- *graphic representation of the positioning* (pane with applied working).

None of the information given is specific to the single sheet or to the single positioning in the sheet.

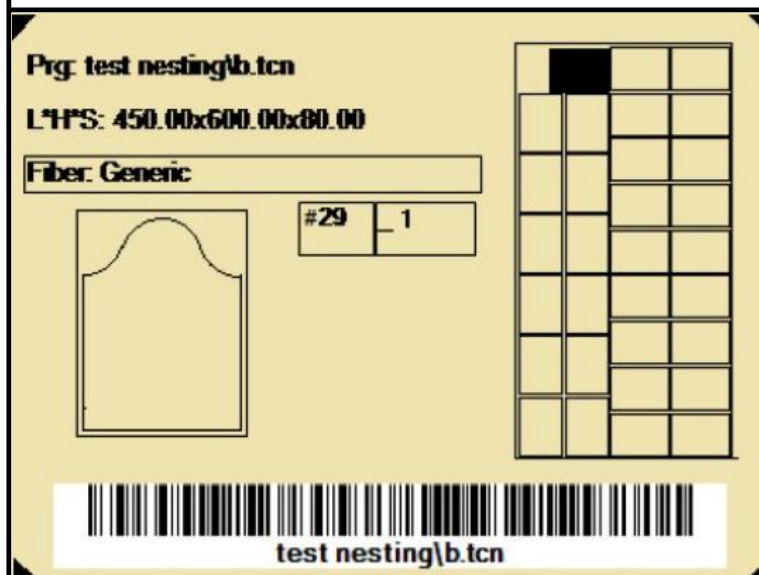

The image shows an example of a label generated **without** an optimized procedure.

The image shows some information similar to the previous case and other specific to the single sheet or to the single positioning. More specifically:

- *consecutive numbers of the pieces*: in this case "#29" ("#1" correspond to the first consecutive number, "#2" to the second, etc.);
- *consecutive number of the sheet*: in this case the value "1" appearing on the right side of the previous field ("1" corresponds to the first panel of the solution; "2" to the second, etc.);
- *graphic representation of the positioning on the sheet* (image appearing on the right side of the label): the rectangles correspond to all the placements on the sheet and the black pane highlights the current positioning.

The use of specific fields of the single sheet or of the single positioning forces the creation of the labels by means of a non-optimized procedure.

## 5 Save the results

The **Save the results**  command registers the TCN files of panels and labels.

The open window shows the information of the folder in which the results were saved.

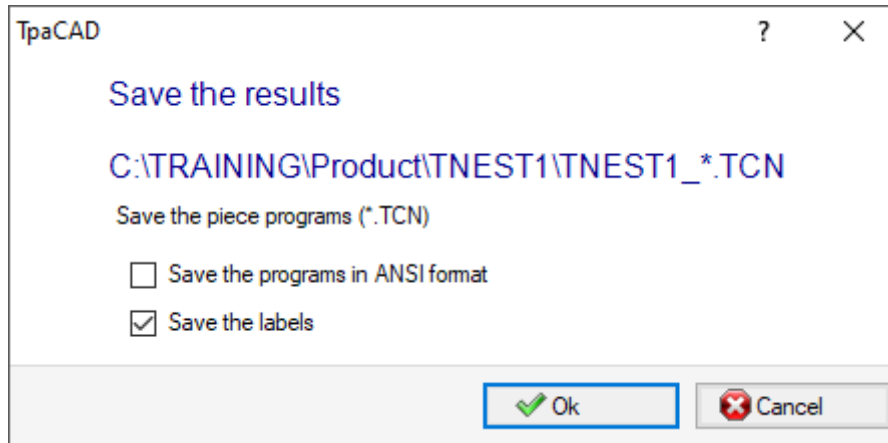

- "C:\TRAINING\Product" is the path selected for the *solution*
- "TNEST1" is the name assigned to the solution.
- "C:\TRAINING\Product\TNEST1" is the folder created to record the files of the solution
- **Save the labels:** keep the case active to generate and save also the files for the images of the labels.

The files of the labels are saved in a dedicated sub-folder: "C:\TRAINING\PRODUCT\TNEST1\LABEL" and the workings **Label-BARCODE** assign the label file name that is related to this path.

**Before executing the command, you can choose whether to delete all the files already saved for the solution: the deletion removes all the files in the solution folder, including records of previous saving. These folders are for the exclusive use of the nesting procedure and must not be used for storing any files.**

If, instead, you choose not to delete the previous solutions saved, the new files are saved in a folder that is created in the root folder of the solution. The name given to this new folder is unique and is obtained by using the date and time, so that multiple folders can be displayed in an orderly way.

A folder example: "C:\TRAINING\PRODUCT\TNEST1\2016-04-17T14.29.09".

At the end of the execution of the command and with at least one processing performed, the path assigned for saving the \*.TCN programs is set as the last opened for a following opening of the program.

The panel saving (\*.TCN) may also include the optimization of the panels themselves: in this case you can manage specific warnings.

The command execution ends by displaying a window indicating the result of the processes carried out. The window shown also allows you to request the saving of other utility files:

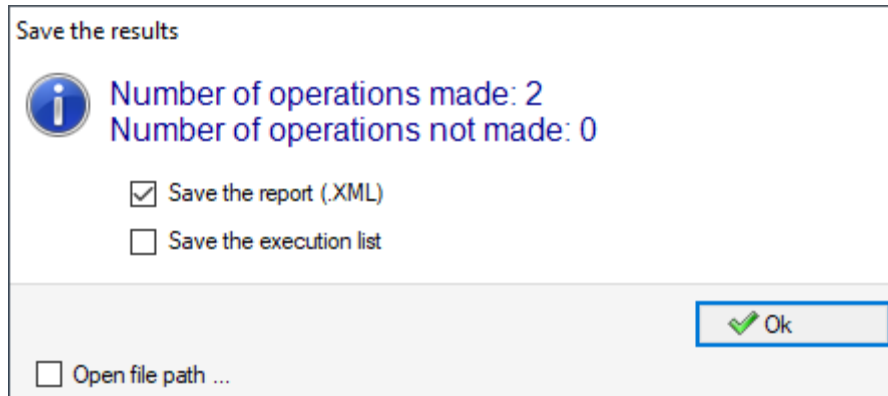

- **Save the report (.XML):** select to request the saving of the report in (.XML) format
- **Save the execution list:** select to request the saving of the execution list (file in XML format and (.XMLST) extension).
- **Save results on completion:** records the TCN files of the panels used in the nesting solution, with the workings excluded from the same solution.

Closing the window performs the saving required, in

- *direct mode*, i.e. without interaction, using the default save folders for each type of file. Or
- *indirect mode*, i.e. with interaction, where you can choose the saving folders for each type of file. This mode is activated by selecting **Open file path...** in the window.

Next to each save command reported in the menu, a check mark indicates which type of files has been saved.

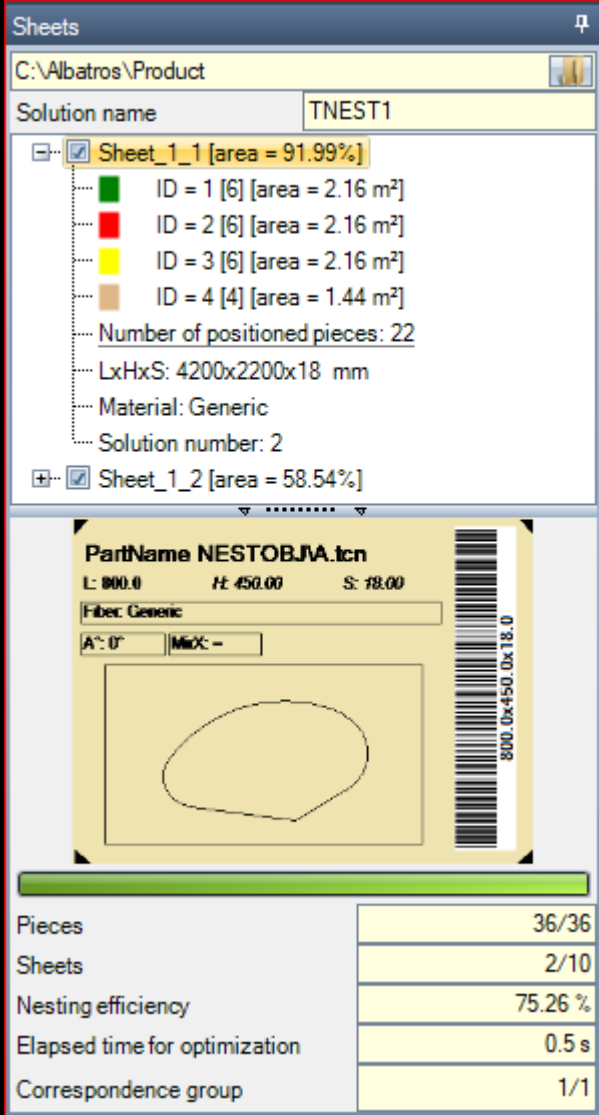

Going back to the example already shown for the solution:

- 2 panels are saved corresponding to as many main enabled nodes
- as already mentioned: panels with errors cannot be saved;
  - colour and ID correspond to the line of the piece in the section of Nesting
  - numbers in square brackets show the quantity used for the panel.

It is clear that it is now possible to see the label recorded for each positioning of the current panel: change the current working by clicking in the area of graphics, to see how the image loaded for the label changes.

Panels (files "\*.TCN") are recorded with:

- direct application of TCN working programs
- insertion of the Label-BARCODE working or integration of the setting, if already available
- insertion of the cut profile(s) of the pieces and of the scraps.

Without cutting path optimization, programming does not apply directly the tool compensation: the tool diameter is read while running each rectangular cutting path and must match the value that was used. The optimized path instead is directly programmed by the application of the tool compensation.

Opening a panel of the solution can be requested in the TpaCAD environment, after closing the operational environment of Nesting. A clarification is however due. The representation of a panel in normal functionality of CAD does not reflect that provided in the Nesting operations: the selections to display areas or cutting profiles or piece identifier of the Nesting functionality remain peculiar aspects of Nesting.

## 5.1 Organization of panels

The solution TCN programs show specific information, some of which allow you to easily *detect* the solution elements. It is highlighted how any information is actually interpretable and accessible only if it is managed, as per **TpaCAD Configuration**. More specifically:

- in *Special Settings* section
  - ✓ information about the panel *grain*
  - ✓ *preview pattern* corresponding to the panel material
  - ✓ *preview colour* corresponding to the panel colour.

## 5.2 Save results on completion

The command **Save results on completion**  records the TCN files of the panels used in the nesting solution, with the workings excluded from the same solution.

The files are saved in a dedicated sub-folder created in the solution folder. If "C:\TRAINING\PRODUCT\TNEST1" is the folder that was created for recording the solution files, the files are recorded in "C:\TRAINING\PRODUCT\TNEST1\EXTRA".

The files are saved with the original modified name by adding a suffix that shows the number of the original row in the nesting project. For example: for the program named "a.tcn" called to the 7th row, a file named "a\_7.tcn" will be recorded.

The files show the excluded workings, because:

- they are programmed on faces different from the upper face of the piece
- they are directly excluded from the nesting solution (see: **Nesting configuration, Exclusions**)

## 5.3 Save unused pieces

The command **Save unused pieces**  records a new nesting project (file with extension (.NCAD)), including the pieces, which were not used in the nesting solution.

The command selection opens the window for the assignment of the file name and its location.

## 6 Prototype of nesting panels

The panels of the solution (.TCN files) are created by means of a prototype file: `PIECE_SHEET.TCN`, in the "TPACADCFG\CUSTOM\NESTING" folder. If the file is not found, the prototype file of the TCN programs is used (`PIECE.TCN`, in the "TPACADCFG\CUSTOM" folder).

To open and change the prototype file, select in the menu of the **Open prototype file**  command from the **Application** menu. More specifically, the prototype file allows the initialization of:

- execution modes (work area, ...)
- 'o', 'v' variables
- custom sections (example: Optimization settings).

The program can also assign the technology to be used for cutting paths of panels, if not otherwise identified (see: **Nesting configuration**). In that case, you must program a setup working as first working on the top face (face 1): the cutting profile(s) of pieces and scraps will begin with a copy of the working.

The program can also assign workings be used when opening and/or closing all the panels of the solution. The workings are recovered from face 1 and possibly also from face 2, if the *Nesting-flip* function is active (see: **Nesting configuration**).

For this purpose, a formalism is defined for assigning the *Description* string for the recognition of the workings:

- "w-head" indicates workings to be assigned to the head
- "w-tail" indicates workings to be assigned to the tail
- otherwise: the workings are excluded, with the only exception of the setup working assigned to the head top face to indicate the cutting profile technology.

In case of profile assignment: the *Description* can be indicated only on the setup.

## 7 Save the executive list

This command saves the file corresponding to the execution list of the panels, created by the previous command.

The format of the file is XML and its extension is (.XMLST), as required by WSC application program. For the functioning of the WSC program, please read the specific documentation.

## 8 Remove nesting results

The command  removes the results recorded for the current solution. The deletion removes the files of the solution folder and may concern also the files related to previous saving processes.

If no nesting solution has been required for the current project, it will be possible to confirm the reset of the solution folder by deleting the files matching previous saving processes. Otherwise, it is possible to confirm the deletion of the last saving files or the files in the entire history of saving solutions.

Execution list and report file are deleted as well, but only if they are saved in correspondence with the current solution.



## 9 Nesting report

Two different types of report of a nesting result are managed.

A first type is provided in ".XML" format and is available for external consultation, for example in order to create customized reports of a production process.

A second type of report is made available to provide a detailed printout of the whole nesting project.

### 9.1 Report ("\*.XML" format)

The information contained in this type of file is essentially intended to make all the information related to the production that follows the solution of a nesting process easily accessible.

The default folder to save the file is the solution folder.

When the nesting results are displayed you can select the command **Save the report (.XML)** .

Below is a diagram of the file:

<pre>&lt;?xml version="1.0" encoding="utf-8"?&gt; &lt;TpaCadNesting version="2.4.0.0"&gt;</pre>	<p>XML file header</p> <p>Main section:</p> <ul style="list-style-type: none"> <li>"version": version of the TpaCAD suite</li> </ul>
<pre>&lt;Header Name="C:\ALBATROS\REPORT\tnest1.XML"&gt;   &lt;Date&gt;05/03/2020&lt;/Date&gt;   &lt;IdOrder&gt;ABC-20-12345&lt;/IdOrder&gt;   &lt;IdProduct&gt;ID456&lt;/IdProduct&gt;   &lt;Unit&gt;mm&lt;/Unit&gt; &lt;/Header&gt;</pre>	<p>Section of preliminary information:</p> <ul style="list-style-type: none"> <li>"Name": complete path of the report file</li> <li>"Date": record date</li> <li>"idOrder", "idProduct": order and product reference of the nesting project</li> <li>"Unit": unit of measurement for the nesting project (mm/inch)</li> </ul>
<pre>&lt;Sheets&gt; &lt;Sheet IdSheet="1"&gt;   &lt;Name&gt;Sheet_1&lt;/Name&gt;   &lt;Quantity&gt;2&lt;/Quantity&gt;   &lt;SizeX&gt;4200.00&lt;/SizeX&gt;   &lt;SizeY&gt;2200.00&lt;/SizeY&gt;   &lt;SizeZ&gt;80.00&lt;/SizeZ&gt;   &lt;Surface&gt;9.24&lt;/Surface&gt;   &lt;Material&gt;Generic&lt;/Material&gt;   &lt;Color /&gt; &lt;/Sheet&gt;  &lt;Sheet IdSheet="2"&gt;   &lt;Name&gt;Sheet_2&lt;/Name&gt;   &lt;Quantity&gt;3&lt;/Quantity&gt;   ... &lt;/Sheet&gt; &lt;/Sheets&gt;</pre>	<p>Section of the sheet types used by the nesting solution. Each "Sheet" section corresponds to one row of the nesting project.</p> <ul style="list-style-type: none"> <li>"IdSheet": sheet type identifier (row number in the project)</li> <li>"Name": name assigned to the type of sheet</li> <li>"Quantity": quantity required for the calculated quantity</li> <li>"SizeX/Y/Z": dimensions of the sheet type</li> <li>"Surface": surface (=SizeX* SizeY) in units [m<sup>2</sup>] or [inch<sup>2</sup>]</li> <li>"Grain": grain of the sheet (displayed value: "x", "y")</li> <li>"Material": assigned material</li> <li>"Color": assigned colour</li> </ul> <p>The list does not show the types of sheet assigned in the nesting project but not used for the solution.</p>
<pre>&lt;Elements&gt; &lt;Element IdElement="1"&gt;   &lt;Name&gt;C:\ALBATROS\PRODUCT\TEST\A.TCN&lt;/Name&gt;   &lt;Description&gt;panel a description&lt;/Description&gt;   &lt;Quantity&gt;20&lt;/Quantity&gt;   &lt;SizeX&gt;600.00&lt;/SizeX&gt;   &lt;SizeY&gt;450.00&lt;/SizeY&gt;   &lt;SizeZ&gt;80.00&lt;/SizeZ&gt;   &lt;Mirror&gt;false&lt;/Mirror&gt;   &lt;Material&gt;Generic&lt;/Material&gt;   &lt;Color /&gt;</pre>	<p>Section of the types of piece used by the nesting solution. Each "Element" section corresponds to one row of the nesting project:</p> <ul style="list-style-type: none"> <li>"IdElement": identifier of the piece (row number in the project)</li> </ul>

<pre> &lt;IdOrder&gt;abc_a&lt;/IdOrder&gt; &lt;Info1&gt;aaa_123&lt;/Info1&gt; &lt;WorkedAll&gt;false&lt;/WorkedAll&gt;  &lt;NameExtra&gt;C: \ALBATROS\PRODUCT\TNEST1\EXTRA\A_1.TCN&lt;/Name&gt;  &lt;/Element&gt;  &lt;Element IdElement="2"&gt; &lt;Name&gt;C:\ALBATROS\PRODUCT\TEST\B.TCN&lt;/Name&gt; ... &lt;/Element &gt;  &lt;Element IdElement="3"&gt; &lt;Name&gt;C:\ALBATROS\PRODUCT\TEST\C.TCN&lt;/Name&gt; .... &lt;/Element&gt; &lt;Element IdElement="4"&gt; &lt;Name&gt;C:\ALBATROS\PRODUCT\TEST\D.TCN&lt;/Name&gt; .... &lt;/Element&gt; &lt;Element IdElement="5"&gt; &lt;Name&gt;C:\ALBATROS\PRODUCT\TEST\E.TCN&lt;/Name&gt; .... &lt;/Element&gt; &lt;Element IdElement="6"&gt; &lt;Name&gt;C:\ALBATROS\PRODUCT\TEST\A.TCN&lt;/Name&gt; .... &lt;/Element&gt; &lt;/Elements&gt; </pre>	<ul style="list-style-type: none"> <li>• "Name": complete path (e.g.: file ".TCN") or name assigned to the piece</li> <li>• "Description": comment to the piece</li> <li>• "Quantity": processed quantity for the calculated solution</li> <li>• "SizeX/Y/Z": piece sizes</li> <li>• "Mirror": mirroring request (true/false)</li> <li>• "Grain": grain of the sheet (displayed value: "x", "y")</li> <li>• "EdgeLeft", "EdgeRight", "EdgeTop", "EdgeBottom": piece edges</li> <li>• "Material": assigned material</li> <li>• "Color": assigned colour</li> <li>• "idOrder": piece order references</li> <li>• "info1".."info10": added information</li> <li>• "WorkedAll": advancement status of the piece, in nesting solution <ul style="list-style-type: none"> <li>• true= the working is complete</li> <li>• false= the working is not complete, due to the exclusion of working (it requires a resumption of the execution).</li> </ul> </li> <li>• "NameExtra": complete path of the recorded program to complete the workpiece.</li> </ul> <p>The list does not show the types of pieces assigned to the nesting project but which are not used for the solution.</p>
<pre> &lt;Results&gt; &lt;Result IdResult="1" IdSheet="1"&gt; &lt;Name&gt;C:\ALBATROS\PRODUCT\TNEST1\TNEST1_1_1.TCN&lt;/Name&gt; &lt;Quantity&gt;1&lt;/Quantity&gt; &lt;AreaPerc&gt;94.86&lt;/AreaPerc&gt; &lt;Elements Quantity="34"&gt; &lt;Element IdElement="1" Quantity="2" /&gt; &lt;Element IdElement="2" Quantity="25" /&gt; &lt;Element IdElement="4" Quantity="6" /&gt; &lt;Element IdElement="5" Quantity="1" /&gt; &lt;/Elements&gt;  &lt;Items&gt; &lt;Item IdItem="1" IdElement="1" Label= C: \ALBATROS\PRODUCT\TNEST1\ LABEL\1_1_1.BMP&lt;/Label&gt;"/&gt; &lt;Item IdItem="2" IdElement="1" Label= C: \ALBATROS\PRODUCT\TNEST1\LABEL\1_1_2.BMP&lt;/Label&gt;"/&gt; ... &lt;/Items&gt;  &lt;Result IdResult="2" IdSheet="1"&gt; &lt;Name&gt;C:\ALBATROS\PRODUCT\TNEST1\TNEST1_1_2.TCN&lt;/Name&gt; &lt;Quantity&gt;1&lt;/Quantity&gt; &lt;AreaPerc&gt;94.19&lt;/AreaPerc&gt; &lt;Elements Quantity="38"&gt; &lt;Element IdElement="1" Quantity="18" /&gt; &lt;Element IdElement="4" Quantity="14" /&gt; &lt;Element IdElement="5" Quantity="6" /&gt; &lt;/Elements&gt; &lt;/Result&gt;  &lt;Result IdResult="3" IdSheet="2"&gt; &lt;Name&gt;C:\ALBATROS\PRODUCT\TNEST1\TNEST1_2_1.TCN&lt;/Name&gt; ... &lt;/Result&gt; &lt;Result IdResult="4" IdSheet="2"&gt; &lt;Name&gt;C:\ALBATROS\PRODUCT\TNEST1\TNEST1_2_2.TCN&lt;/Name&gt; ... &lt;/Result&gt; &lt;Result IdResult="5" IdSheet="2"&gt; </pre>	<p>Section of the sheets processed by the nesting solution. Each "Result" section corresponds to a ".TCN" program of the solution:</p> <ul style="list-style-type: none"> <li>• "IdResult": sheet identifier (sequential number)</li> <li>• "IdSheet": identifier of the sheet type (see section: "Sheets")</li> <li>• "Name": complete file path (".TCN")</li> <li>• "Quantity": sheet repeater</li> <li>• "AreaPerc": area cut by the sheet (as a % of the total)</li> <li>• "Elements": section of the pieces processed on the sheet ("Quantity": total of the pieces). Each section "Element" corresponds to a single type of piece:</li> <li>• "idElement": piece identifier (see the section on the "Elements" main level)</li> <li>• "Quantity": processed quantity on the current sheet.</li> <li>• "Items": section of the pieces worked on the sheet. Each "Item" section corresponds to a single piece:</li> <li>• "IdItem": sequential number of placement on the sheet (<math>\geq 1</math>)</li> <li>• "idElement": piece identifier (see the section on the "Elements" main level)</li> <li>• "Label": complete path of the label that has been recorded at the placement.</li> <li>• "XC/YC": center of the bounding-box of the placement. If the piece is assigned with typology of <i>Shaped</i></li> </ul>

<pre>&lt;Name&gt;C:\ALBATROS\PRODUCT\TNEST1\TNEST1_2_3.TCN&lt;/Name&gt; ... &lt;/Result&gt; &lt;/Results&gt;</pre>	<p>workpiece or <i>Nesting geometry</i>, the position can be external to the piece.</p> <ul style="list-style-type: none"> <li>• "A": angle of rotation of the placement (unit degrees, positive corresponds to anti-clockwise rotation).</li> </ul>
</TpaCadNesting>	Closes the main section.

## 9.2 Report ("\*.PDF" format)

When the nesting results are displayed it is possible to select **Reports**  command, as to generate a detailed report of the whole nesting project.

A window shows the report preview:

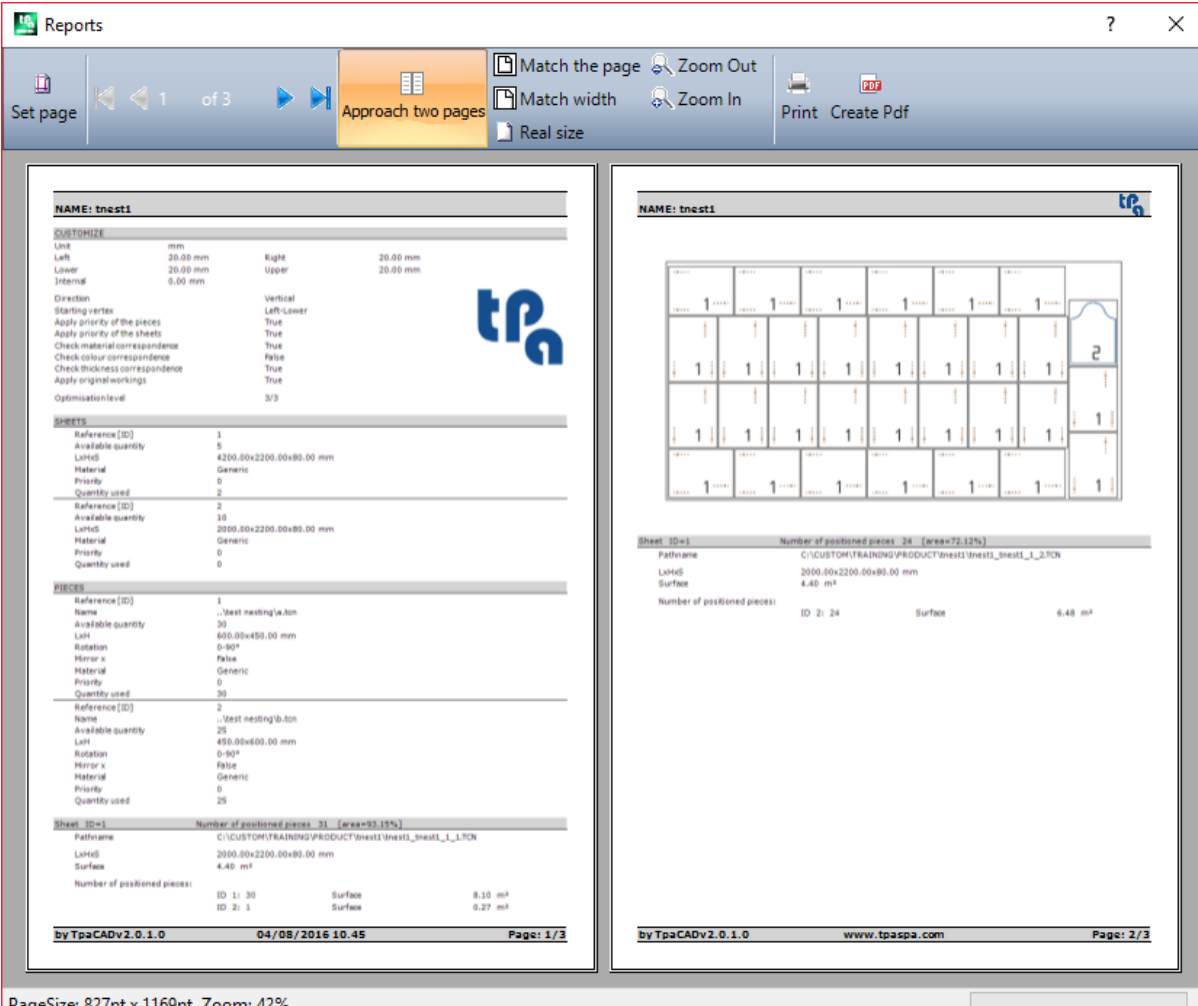

**NAME: tnest1**

**CUSTOMIZE**

Unit	mm		
Left	20.00 mm	Right	20.00 mm
Lower	20.00 mm	Upper	20.00 mm
Internal	0.00 mm		
Direction	Vertical		
Starting vertex	Left-Lower		
Apply priority of the pieces	True		
Apply priority of the sheets	True		
Check material correspondence	True		
Check colour correspondence	False		
Check thickness correspondence	True		
Apply original markings	True		
Optimization level	3/3		

**SHEETS**

Reference ID	1
Available quantity	5
Length	4200.00x2200.00x80.00 mm
Material	Generic
Priority	0
Quantity used	2
Reference ID	2
Available quantity	10
Length	2000.00x2200.00x80.00 mm
Material	Generic
Priority	0
Quantity used	0

**PIECES**

Reference ID	1
Name	..nest nesting/a.ton
Available quantity	30
Length	600.00x450.00 mm
Rotation	0-90°
Mirror x	False
Material	Generic
Priority	0
Quantity used	30
Reference ID	2
Name	..nest nesting/b.ton
Available quantity	25
Length	450.00x600.00 mm
Rotation	0-90°
Mirror x	False
Material	Generic
Priority	0
Quantity used	25

**Sheet ID=1** Number of positioned pieces: 31 (area=93.13%)

Pathname	C:\CUSTOM\TRAINING\PRODUCT\Tnest1\Tnest1_sheet1_1.TCN
Length	2000.00x2200.00x80.00 mm
Surface	4.40 m²

Number of positioned pieces:

ID 1:	30	Surface	8.10 m²
ID 2:	1	Surface	0.27 m²

by TpaCADv2.0.1.0 04/08/2016 10.45 Page: 1/3

**NAME: tnest1**

**Sheet ID=1** Number of positioned pieces: 34 (area=72.12%)

Pathname	C:\CUSTOM\TRAINING\PRODUCT\Tnest1\Tnest1_sheet1_3.TCN
Length	2000.00x2200.00x80.00 mm
Surface	4.40 m²

Number of positioned pieces:

ID 2:	24	Surface	6.48 m²
-------	----	---------	---------

by TpaCADv2.0.1.0 www.tpaspa.com Page: 2/3

Page Size: 827pt x 1169pt, Zoom: 42%

The report contains the information about:

- nesting project: list of pieces and panels, nesting parameters
- the features of each panel of the solution, including the layout representation. The layout of each single panel is generated with the settings:

**View areas**= OFF;

**Cutting profiles**= OFF;

**Identify the pieces**=ON/OFF as selected in the *Nesting configuration* (page: *Advanced activations*)

**Consecutive numbers of the pieces**= ON/OFF as selected in the *Nesting configuration* (page: *Advanced activations*)

With both fields of identification of the pieces, there will be a writing in an "ID/#NP" format where:

"ID" corresponds to the item **Identify the pieces**

"NP" corresponds to the item **Consecutive numbers of the pieces**

**Labels** = OFF.

If the file associated with the executive list of panels ("XMLST" extension file) has been recorded, the report document ends with the barcode associated with the name of the recorded file:



The window shows the usual commands of a preview window, where it is possible to:

- change page settings
- change the zoom (from the menu or the mouse through command (CTRL+Mouse wheel))
- scroll the pages and select the criterion for the arrangement of the pages.

It is possible to print the report by selecting the print module.

More specifically, it is possible to convert and to save in a PDF document by selecting a proper conversion module installed on the device for this purpose.

The maximum number of the pages for a report is 150.

## 10 Print labels

To print directly the labels the following two commands are available:

- **Print the current label:** prints the label of the current positioning, that is, the label matching the display in the area of the results.
- **Print the labels of the panel:** prints the labels of all positionings of the current panel. In the case of the same label for several positionings, the print process is repeated for all the occurrences needed.

Selecting one of the print commands, a confirmation window appears. If assigned in configuration, the window shows the printer already selected to print the labels, where it is possible to change the selection. Each label is printed on a new page.

# 11 Nesting configuration

Nesting configuration command is available in a menu  with a closed program and at a level, as set in **TpaCAD configuration**.

The settings for the dimensions to use match the **Unit of measure of the configurations**, in [mm] or [inch].

## 11.1 Pieces

Page of settings regarding the assignment of the pieces for a **Nesting** project.

- **File type**: check the boxes of the piece types you want to manage and the manual cluster box if you want to enable the manual cluster management.
- **Assign the TCN file dimensions (LxH)**: the checked box enables the change of the original dimensions (length, height) of the TCN programs.
- **Assigns the thickness of the TCN files**: the checked box enables the modification of the original thickness of the TCN programs.
- **Assign "r" variables**: the checked box enables the change of public "r" of TCN programs and the control of the associated column.
- **Assign the name of the rectangles**: the checked box enables the assignment of the **Name** field when the type of the piece is Rectangle.
- **Assign priority**: the checked box enables the assignment of the piece priority and the control of the associated column.
- **Assign the edges**: the selected checkbox enables the assignment of the piece edges and the control of the associated columns.
- **Edge codes**: the option corresponds to a table with a maximum of 50 rows, to identify as many characteristics for the edges of a panel. Each row can assign a code whose maximum length is 25 characters; while loading, the list is compacted, with the elimination of empty or repeated assignments.
- **Added Info**: sets the number of generic information to be added in piece assignment, up to a maximum of 10 (value 0: assignment management is excluded). Assignments are string type. The picture corresponds to a set value of 5:

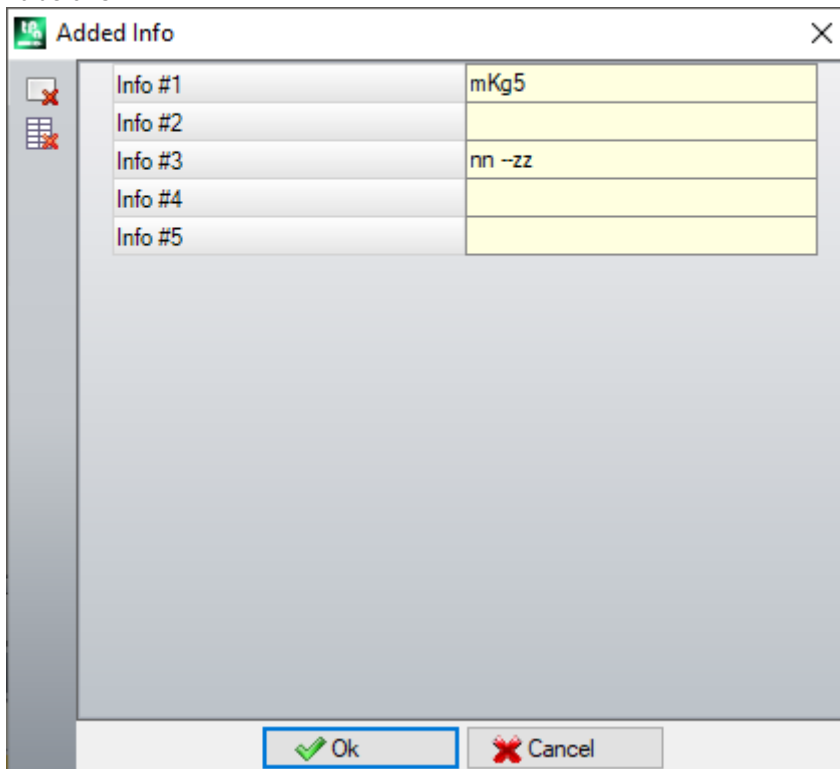

It is recalled that the messages of the single fields (as shown in the picture: "info #1", "Info #2",...) are assigned in the CADAUX custom message file (in the folder: TPACADCFG\CUSTOM) to the ID messages assigned in range [1601-1610].

## 11.2 Sheets

Page of settings regarding the assignment of the panels for a **Nesting** project.

- **Assign name:** the checked box enables the assignment of the **Name** field of the sheets
- **Assign priority:** the checked box enables the assignment of the panel priority and the control of the associated column.
- **Assign colour:** the checked box enables the assignment of the colour of the panels and the control of the associated column. The activation is applied both to pieces and panels.
- **Material and Patterns:** this entry matches with the table of no more than 50 rows to identify the same number of characterizations for the panel type, generically identified as Material and with a filling pattern associated with the material. The additional row on the top of the list correspond to the assignment by default: if there is not any further element in the list, the assignment of the material will be disabled. The cells in the column **Material** can be edited directly, when a significant material denomination is assigned.

A click in the **Patterns** column cell opens the window of the image files stored in the configuration folder (TPACADCFG\CUSTOM\DBPATTERN): the formats recognized as valid are \*.JPG, \*.PNG, \*.BMP and it is

required to select a file in the assigned folder. To cancel the name of a set pattern, click on the icon 

The setting is applied to both pieces and panels.

## 11.3 Exclusions

- **Excluded workings:** this table assigns the list of the workings to be excluded during Nesting development. This table lists the workings:
  - point, setup or custom logic
- complex workings (codes of macro) that cannot be exploded: check the workings to exclude. Excluding the workings enables the view of the *Excluded workings* column in the Piece list of a Nesting project.
- **Property:** property assignments to be searched: (examples: "L=1", "M=250"). If the field is not assigned, the research does not apply to the properties of a working; otherwise, while developing the nesting, any type of workings is excluded that verify the correspondence on the properties marked by a positive value; a profile is always calculated on the setup. The field must assign the items separated by space, where each item is called with the property name (L for Layer, then: O, M, K, K1, K2) followed by the associated value (for the K1 and K2 fields the "K1=.." form is obligatory). B (construct) and C (comment) field assignments are excluded and the assignments must be numerical. Any filter is cumulative of all the properties assigned with positive values.
 

Examples:

  - "L4 M5000" the exclusion of a working must check the numerical correspondence with two properties
  - "L0 M5000" the exclusion of a working checks the numerical correspondence with the property M=5000, while the one with the property is filtered, because it is assigned with value 0.

All the mentioned exclusion conditions are individually applied: you only need to check a condition to exclude a working.

## 11.4 Nesting options

**Rectangular nesting:** group of settings used in the calculation of *rectangular* placements

- **Sorting of pieces:** it defines how to sort the pieces, while preparing the list to place. Four options are available:
  - **big pieces first:** it sorts by decreasing area
  - **according to the direction:** it sorts by decreasing values of the size matching the direction of the nesting, as assigned on the single nesting project:
    - a) if the direction is horizontal, it sorts by decreasing height
    - b) if the direction is vertical, it sorts by decreasing length
  - **combined (area and direction):** it applies a sorting that can combine the two previous criteria. The selection can determine an increase of the number of iterations that a nesting solution is able to perform

- **little pieces first:** it sorts by increasing area

While applying the sorting of the pieces by area, when pieces are compared with the same area, the following criteria are applied according to the proposed order:

- *the pieces with a smaller perimeter first:* for example, a square takes precedence over a rectangle
- *the pieces whose required quantity is greater first*
- *apply the order assigned in the list.*

**Compare the solutions of a sheet:** group of settings used during the comparison of possible solutions, in order to determine the "best solution"

- **Maximize the area occupied by the placements:** select this entry to give priority to the solution that maximizes the area concerning the placements. Making reference to the figure:

$A_i$  indicates the area concerning the rectangular placements; it is enclosed by the limit coordinates of the placements. The difference between the  $A_i$  area and the area of all the placements corresponds to the area of the *offcuts inside* the nesting

$A_e$  indicates the area outside the placements and corresponds to the area of the *offcuts outside* the nesting.

The criterion of maximizing  $A_i$  area does not apply absolutely, but it is mediated in the area of the smaller piece and in the following principles.



If the field is not selected, the criterion of comparison of the areas concerning the positioning is not excluded, but it is applied with less relevance.

- **Maximize the orderly arrangement of the placements:** select this item to give priority the "more orderly" solution: this evaluation is based on a comparison of offcuts ( $A_i$  area), of grid arrangement of the placements and of the number of the pieces. Also, in this case, if the field is not selected, the criterion of comparison is not excluded, but it is applied with less relevance
- **Max. offset value of the off-cuts inside the placements (%):** set the maximum allowed offset value for the internal offcuts, now calculated as a percentage with respect to the  $A_i$  area. The field accepts values in a range (1 - 50). The use of the value is not absolute: coupled to one or to both criteria, may determine the choice of one of two solutions.

**Nesting True Shape:** group of settings used in the calculation of the *True Shape* placements

- **Maximum time of calculation (sec):** it sets the maximum time to apply during the calculation of the *True Shape* placements
- **Minimum use of the sheets (%):** sets the area placements in percentage on the overall rectangle of the placements themselves (the  $A_i$  area of the previous drawing). Reaching the value set here represents a closing condition of the calculation phase, as an alternative to reaching the maximum calculation time. It is



possible to set a value between 50 and 95: the greater the value, the more demanding the condition of acceptance of a valid solution.

- **"Any" rotation in nesting True Shape:** it sets the angle that corresponds to the selection of the rotation "any" to be applied during the calculation of *True Shape* placements. It is possible to set a value between 5 and 90, with a unit of grade (examples: 60, 45, 30, 20, 15). The minimum value of rotation really applied is attributed to a sub-multiple of 360°. The less the set value is and more demanding the phase of positioning calculation will be, both in terms of requested memory and in terms of time necessary to reach the determination of a valid solution for positioning.
- **Optimization in automatic clusters (%):** it sets the value of minimum use of the area with an automatic cluster of the pieces with respect to single placements. The setting has a meaning similar to the next one and is used for the autonomous application of an automatic cluster.
- **Minimum optimization in automatic clusters (%):** it sets the value of minimum use of the area with an automatic cluster of the pieces with respect to single placements. An automatic cluster consists of generating a group obtained on a single piece with cluster of the piece as a copy of itself rotated of 180°. The figure shows an example of the single piece on the left side and, on the right, the group can be obtained with automatic cluster.



The efficiency of the use of an automatic cluster is calculated as:

$$(\text{Area of the single piece} * 2 * 100) / (\text{Group length} * \text{Group height})$$

A cluster that assigns an efficiency higher or equal to the value here configured can determine a group privileged application with respect to the placement of the single piece.

- **Overlapping nesting profiles:** select to allow overlapping cutting profiles. The maximum overlapping allowed corresponds to the tool with the smallest diameter used in execution of the cut profiles, with subtraction of the **Safety distance for overrun**. This option is also applied in the case of a rectangular nesting of **Shaped workpieces** and /or **Nesting geometry**. Let us see the previous example with active selection, now the overlapping of profiles is clear.

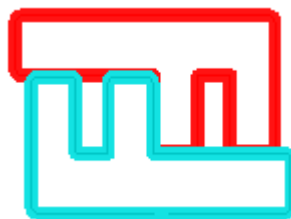

**Manual cluster nesting:** a group of settings used in calculating a manual cluster nesting:

- **Check the correspondence between cluster and pieces:** checks that the thickness, material and colour data of the cluster match the data of the component parts
- **Optimize all in True Shape:** if enabled and the True Shape optimization is requested, all the list parts are considered as shapes. The option is significant only if there is at least a cluster enabled in the list of pieces. By activating this option, the scrap areas resulting from manual cluster nesting will be optimized.
- **Safety distance for overrun:** it sets the distance to be added to the pieces nested with rectangular logic, if workings to be performed outside the piece have been found, or with true-shape logic, by selecting

**Overlapping nesting profiles.** The field has unit of measurement [mm]/[inch] and accepts values in a range (0.1 – 10.0) mm.

- **Shapes: Evaluate the external geometries:** the selection affects pieces inserted in the nesting project as **Shaped workpieces**. Select to evaluate the overall dimensions outside the *Nesting geometry* boundary rectangle for the assignment of a respect area around, in order to safeguard the placements adjacent to the Nesting geometry.
- **Lower priority with increasing value:** defines how the priority value is interpreted in pieces, clusters and sheets. If the option is disabled, the priority is increasing (0= lower priority, 100= higher priority). If the option is enabled, the priority is decreasing (0= higher priority, 100= lower priority). The default is ascending priority and option disabled.

The remaining entries of the page set how a panel of the solution (“.TCN” file) is defined.

- **Create a folder per solution:** the selected box requires the creation of a folder to store data related to a solution. This box is selected and cannot be changed.
- **Optimize:** the selected box requires the execution of the optimization of the panels, together with their recording. The application of the selection is conditioned by the actual availability of an optimization module.
- **Export:** the selected box requests to run the format export of the panels, at the same time as its recording. The selection is only available in **Professional** mode and if an export module is configured for the *Nesting* functionality or, alternatively, it is to be applied when recording a TCN program. The selection is applied if no optimization is requested and also when the complementary programs are recorded.

**Nesting solution:** group of settings used during the execution of the corresponding tool that can be applied to the program

- **Open prototype:** select this option to use the prototype file of the nesting panels.

## 11.5 Sorting logic

The page selections determine the sorting and optimization criteria for registering the TCN panels corresponding to the nesting results.

- **Sort the placements:** selects the type of sorting required for placements on a sheet. There are five options available:
  - **do not apply:** the placements follow the order assigned by the nesting calculation procedures. In case of a sheet with mixed solution, first the rectangular placements and then the True Shape ones are solved.
  - **according to the direction:** placements are sorted in columns or rows, based on the direction and vertex selected for nesting development. In the figure, the case of sorting with *horizontal* direction and *left-lower* vertex (on the left the areas are displayed): the numbers shown are the consecutive numbers of the placements.



- **direction+Greek pattern:** a grid layout is combined with the previous sorting, with inversion of the direction of the placements in each column or row

- **external frame:** the placements are sorted following the external frame and moving more and more towards the inner part of the sheet. The sorting start is according to the direction and vertex selected for nesting development
- **from inside to outside:** placements are sorted by reversing the order of the previous criterion.

The sorting type can also be changed directly from the menu for each individual nesting project.

The sorting is performed in the nesting calculation phase and is preliminary to the registration of TCN files.

As a default condition, the nesting calculation phase generates TCN files as follows:

- a) **placements:** all placements are sorted as defined above, and each one includes:
  - ✓ the workings deriving from the programs which have been nested
  - ✓ the labels, added or already present in the original programs
- b) **pre-cutting profiles:** profiles added by the nesting procedure as workings **[CUTRECT] Cut of rectangle** or as **Optimized profile** (see next paragraph)
- c) **cutting profiles of the islands:** all profiles taken from individual placements (programmed as *scrap areas*)
- d) **cutting profiles:** all profiles taken from individual placements (programmed as *nesting areas*) and cutting profiles added by nesting procedure (single or optimized)
- e) **cutting profiles of the external scraps:** profiles added by the nesting procedure to cut the scrap parts outside the sheets.

Starting from this default organization, the following entries add new optimization criteria:

- **Group workings by type:** with active selection, all the workings corresponding to the previous **a)** item are now reorganized according to the logic:
  - ✓ **drilling workings:** sorted as resulting from the order of individual placements
  - ✓ **generic milling** (i.e.: those not corresponding to scrap or nesting areas). The order derives from the order of the single placements, with possible sub-groupings deriving from the application of the next option (**Minimize tool changes**). This group includes the pre-cut profiles generated for the placements corresponding to **Shaped workpieces** and **Nesting geometries**
  - ✓ **other workings:** sawing, insertions, custom-type logic workings, .. (labels excluded)
  - ✓ **labels:** LABEL workings are grouped at the end of all the generic workings
- **Minimize tool changes:** with this selection active, all the above-mentioned profile groups are sorted to minimize tool changes. The procedure also takes into account the possibility of assigning a Technological priority information to the milling Setup workings.

For each individual group of profiles, optimization lists:

- first all profiles with *Technological Priority = 0*, with groupings by tool
  - then the profiles with *Technological Priority = 1*, with groupings by tool
  - ..
  - until all the profiles have been exhausted.
- **Keep separate placements:** with selection activated, all the workings corresponding to a single placement are kept grouped and can be sorted according to the previous two selections. With selection activated, a TCN file will have the following structure:
    - first all the workings of the first placement, with application of any grouping per type and tool change. The pre-cut and cutting profiles are taken to the end of the group
    - then all the workings of the second placement, by applying the same criteria
    - ..
    - until all the placements have been exhausted
    - any profiles of optimized cutting or cutting of off-cuts outside the sheets close the list of workings.

## 11.6 Cutting profiles

Page to set the cutting profiles:

- **Global technology (tec\..):** select an entry of the available global technologies to be used to carry out the cutting profiles. If there is no assignment, the technology must be assigned in the (.TCN) nesting prototype file. The cut profile(s) of the pieces will begin with a copy of the working. The technology is used under resetting of the properties: construct, profile extrusion. The technology is used for the cutting profiles introduced by the Nesting procedure for the types of pieces **Panel (\*.TCN)** and **Rectangle**.



To avoid compromising the result of a nesting, it is recommended not to assign segments, that lead to a side entry or exit to the cutting profile.

- **Feed-through Z:** set the feed-through position assigned to the cutting profiles. The sign is not significant because a depth beyond the thickness of the panel is calculated anyway. The minimum value is 0.0, the maximum value is 5.0. Example: 1.5 value -> the cutting profiles set a working depth equal to the thickness of the sheet + 1.5. If the thickness of the sheet is 30 mm, the execution depth will be calculated at -31.5 mm.  
The value set here also assigns the depth of execution of profiles that come from the application of a piece correspondent to *Nesting geometry*
- **Interpolation speed:** set the programmed speed along the cutting profiles. If the set value is 0, and the item **Optimize paths** is assigned, the working speed of the tool is directly assigned.
- **Colour:** select the colour for the representation of the profile(s).

**Pre-cut:** group of settings related to the execution of pre-cut cycles for the correct detachment among small pieces.

- **Enable:** select to enable the functionality. With an active selection pieces are detected according to dimensions (area and/or length/ height) and for each piece a preliminary rectangular cutting path is performed with a non-feed-through depth. The activation is ignored if this working is not available: **[CUTRECT] Cut of rectangle**. The option is used for the cutting profiles introduced by the Nesting procedure for the types of pieces **Panel (\*.TCN)** and **Rectangle**; for the remaining types of pieces, see below.  
In case the option **Apply Z feed** is enabled (see later on), the pre-cut profiles perform passages at subsequent depths. If all the pieces of a sheet are "small" and if **Optimize paths** is enabled (see later on), the pre-cut is performed with optimized profile (with **Apply Z feed** enabled, it can insert more passages).
- **Global technology (tec\..):** select an item from the available global technologies to be used to execute pre-cut profiles. If no assignment is performed, it uses the already assigned technology for executing cuts. The technology is used only if it assigns a tool diameter at most equal to that of the primary technology and after setting to zero following properties: construct, profile extrusion. The technology is used to pre-cut only *Panel* or *Rectangle* type pieces.
- **Minimum area:** it sets the minimum area of endurance of a piece in machine. A piece is considered "small" if its area is calculated as: length\*height is less than the set value. Set the value 0.0 to undo the application of the test
- **Minimum dimension:** it sets the minimum size of endurance of a piece in machine. A piece is considered "small" if one or both dimensions are less than the value set. Set the value 0.0 to undo the application of the test
- **Residual thickness:** it sets the thickness that the tool leaves on the piece during the execution of the pre-cut paths
- **Apply to all pieces:** select to enable the execution of pre-cut cycles to all the placements, regardless of their size (the values assigned in **Minimum area** and **Minimum dimension** are ignored). If the option **Optimize paths** is enabled (see later on), the pre-cut is performed with optimized profile (with **Apply Z feed** enabled, it can insert more passages)
- **Move up the cut of small pieces:** select to require advance cutting of the pieces considered "small" (the execution is made with working: **[CUTRECT] Cut of rectangle**). This option is ignored if all the pieces are "small": it is therefore recommended to assign significant values for the fields **Minimum area** and **Minimum dimension**. A following optimized cutting path (see: **Optimize paths**) will also repeat the cuts corresponding to "small" pieces.

**Cut of rectangle:** group of settings related to the application of non-optimized cutting profiles

- **Counterclockwise rotation:** select to develop the cutting profiles in counterclockwise direction.
- **Cutting setup on one side:** select this option to develop the cutting profiles with a setup point positioned along one side of the cut perimeter. To avoid compromising the result of a nesting, in execution of the cutting profiles the possible setting of **Enter/Exit profile** segments is cancelled, if they are assigned for the cutting technology.
- **Fillet radius:** it sets the fillet radius on the vertexes of the cut rectangles. The setting is significant, only if the **Cutting setup on one side** option is active. If the field assigns a significant value, all cut rectangles perform a fillet on the corners. **WARNING:** a value not greater than ¼ of the minimum dimension of the rectangles that can be nested is valid.

**Optimize paths:** group of settings concerning the optimization of the cutting profiles

- **Enable:** select to enable the optimized. Optimization consists of performing of a single cutting profile with a maximum reduction of the repeated segments. For further details, see the next field. If the selection is not active, for each piece a path of separated cut is carried out with rectangular development. The activation is forced as active, if no working is available: **[CUTRECT] Cut of rectangle**. To avoid compromising the result of

a nesting, in execution of the cutting profiles the possible setting of **Enter/Exit profile** segments is cancelled, if they are assigned for the cutting technology.

- **Maximum movement over the piece:** set the maximum disposition you can perform over the piece, without interrupting the profile. The minimum value is 0.0 mm. Minimum value is 0.0 mm. This setting will lead to the cutting profile fragmentation into multiple separate profiles. The benefit of separate profiles may be that the profiles can be joined to each other with non-interpolated (and therefore faster) movements. If you set a great value (example: 100000) the optimized profile will be unique and the segments geometrically separated are joined by movements over the piece. If you set a lower value (example: 200.0) the profile will be split up into multiple profiles when the joining segment is longer than the set value. Set value to 0.0 to break up the profile at each joining segment.
- **Z air:** set the rise position of the joining segments carried out above the panel. The minimum value is 1.0 mm.
- **Speed of movements over the piece:** set the programmed speed along the segments carried out over the panel. If the field sets a null value, or if it is impossible to use a significant (not null) value for **Interpolation speed**, the movements over the piece do not change their speed compared to the segments interpolated in the piece.
- **Apply zig-zag depth entry:** select to enable automatic application of entries in the piece, such as to not compromise the result of nesting and with a distribution of the feed in depth.
- **Segment length:** set the length of the movements executed on the XY plane, in application of the previous enabling (minimum value is 10.0 mm, maximum value is 100.0 mm). The figure shows how the automatic entry in the piece is applied:

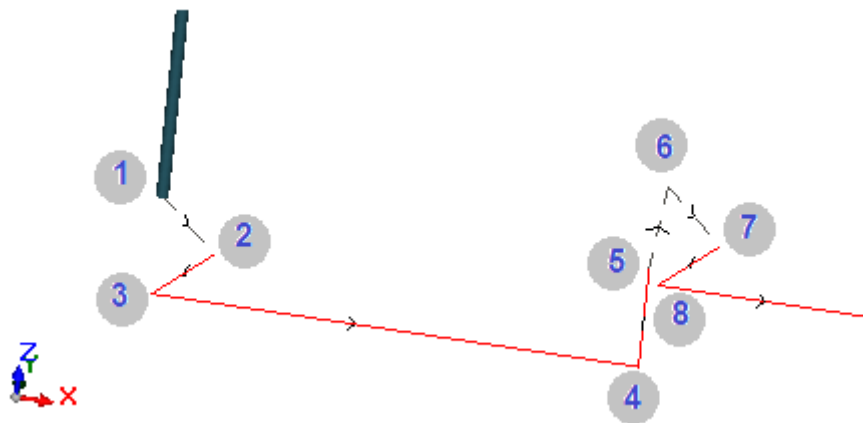

- Point 1: is a Setup point (start of cutting profile). Coordinates (X;Y) correspond to the position of profile start, coordinate Z is assigned to **Z air**
- Point 2: linear segment along the direction of the first cut element (as shown in the figure: along the positive direction in X) and with Z variation equal to half the cutting depth (ex: Z=-15). The displacement of X is equal to the **Segment length** (ex: 40.0mm)
- Point 3: linear segment with displacement of X as opposed to the previous one and final Z to the cutting depth (ex: Z=-30)
- Point 4: linear cutting segment in the piece
- Point 5: up linear segment to **Z air**
- Point 6: linear segment to **Z air** and final coordinates (X;Y) corresponding to the start of the next cutting segment in the piece
- Points 7, 8: replicates the situation of the points (2, 3), with the final achievement of the starting position of the cutting segment in the piece.

The resumption of the cutting profile (figure points from 5 to 8) corresponds to the possibility of performing movements over the piece without any profile interruption. Otherwise, each cutting profile starts with a new setup and a sequence of lines similar to the points of the figure (from 1 to 3).

**Apply Z feed:** group of settings concerning the development of the cutting profiles on more passes and the following feeds of the work depth.

- **Enable:** select to enable the application of following passes
- **Maximum feed:** set the maximum depth of each pass (minimum value: 3.0 mm). The actual value of a pass is automatically recalculated, in order to homogenize the passes in the piece and for a maximum number of

passes that, if the path optimization is active, is set to 10. Example: thickness of the sheet 30.0 mm, maximum feed 12.0 mm, feed-through Z 1.5 mm: the first pass is at Z-10.5, the second at Z-21.0, the third at Z-31.5

**Apply bridges to profile:** group of settings to develop bridges while executing the cutting profile at the final depth.

- **Enable:** select to enable the application of bridges
- **Number of bridges:** set the number of bridges to distribute on a cutting profile, if it is not optimized. The field can only accept values between 2 and 50. If the optimization of the path is active, the setting is not significant.
- **Distance between subsequent bridges:** sets the linear distance of subsequent bridges (minimum value: 30.0 mm). If the optimization of the path is not active and if the **Number of bridges** is greater than 2, the distance set here can be recalculated in order to distribute at least the number of the bridges required.
- **Length of bridges:** sets the length of the bridge (in the XY plane of the sheet)
- **Residual thickness:** sets the thickness left by the tool in the piece when executing the bridge
- **Tool compensation:** select to apply the external compensation of the tool (each bridge is generated as large as the tool diameter).
- **Minimum area:** select to require the application of the previous settings according to evaluations of minimum area. A piece is considered "small" if its area is lower than the value set in the **Pre-cut** group in the field **Minimum area** (if the value is null, it uses an area with value **Minimum dimension \* Minimum dimension**). If the selection is active, it is applied in the execution of cuts of small pieces only, if the cuts are performed with a rectangular cut.

The effectiveness of creating cutting paths with development of bridges should require having a non-null margin between the placements: in this case, the cut of one part cannot be covered by another cut. If it is required to apply bridges on small parts only, set for example:

**Apply bridges to profile ->Minimum area:** selected  
**Optimize paths ->Enable:** selected

The small parts are in any case cut before the others, with a rectangular path and assignment of bridges, while the remaining parts are cut with an optimized profile and without generation of bridges.

**Cut of the scraps:** group of settings concerning the development of the cutting profiles of the scraps. The technology used is the same as the cutting profiles of the pieces.

The cutting profiles of the scraps can be inserted in case of panels *only* applying **Panel (\*.TCN)** and **Rectangle** types of pieces.

- **Enable:** select to enable the development of the cuts.
- **Colour:** select the colour representing the profile(s).
- **Feed-through Z (+/-):** set the value of the lowering Z beyond the thickness of the panel and carrying the scraps. Now the sign is significant: the value set is added with the sign at the depth that corresponds to the thickness of the panel. Examples: value 2.5, the segments leave a residual thickness of 2.5 mm; value -2.5, the segments are performed as 2.5 mm feed-through segments (the examples apply in reverse in the case of depth programmed positive when enters the piece). At the most, it is possible to assign a 5.0 mm feed-through Z, while the value of residual thickness is valued in comparison to the thickness of the panels.
- **Cut the edge:** select to cut until the edges (a segment reaches the edge and the overall dimension of the tool exceeds the radius). If this entry is not enabled, the cuts stop before the edge and leave some residual material (1.0 mm).
- **Minimum length:** minimum dimension of one scrap, measured along the outer edge of the cut (minimum value: 30.0 mm)
- **Maximum length:** maximum dimension of one scrap, measured along the outer edge of the cut (minimum value: 50.0 mm)
- **Minimum width:** minimum size of one scrap, measured along the development of the cut (minimum value: 30.0 mm)
- **Maximum width:** maximum dimension of one scrap, measured along the development of the cut (minimum value: 50.0 mm)

Cutting profiles of the scraps are separated developments: a cut corresponds to a profile.

In case of an execution technology assigned with a **Global Technology (tec\..)**, during the execution of cutting profiles, a possible setting of the segment of **Enter profile** is undone.

The figure shows a panel with two cuts: each shows the direction of the application of the length (L) and height (H) parameters.

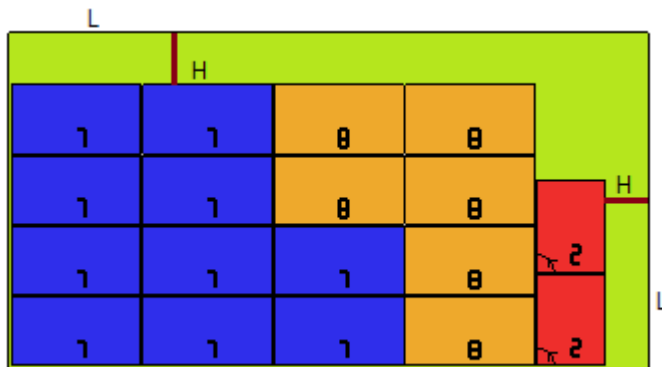

**Shaped workpiece:** group of specific settings for the application of pieces of assigned type

- **Pre-cut:** select to activate the functionality, as mentioned above. The pre-cut path corresponds now to the programmed profile and is only generated for those profiles that program a pass-through depth on the setup or on one of the first (3) profile workings. If the option **Minimum area** (see below) is enabled, profiles are identified for the application according to the area. The function application uses the settings of the **Pre-cut** group, with the exception of the assignment of Technology: the pre-cut profile is performed by means of the technology of the original profiles.
- **Apply bridges to profile:** select to enable the functionality. If the option **Minimum area** (see below) is enabled, profiles according to the area are identified for the application. The function application now changes the programmed profile(s), with distribution of bridge points and concerns the single profiles that program a depth of the feed-through setup. The function application uses the settings of the **Apply bridges to profile** group. If also a pre-cut is generated for a profile, the ascent depth of the bridges corresponds to the residual thickness of the pre-cut
- **Minimum area:** select to require the application of the previous settings according to evaluations of minimum area. A piece is considered "small" if its area is lower than the value set in the **Pre-cut** group in the field **Minimum area** (if the value is null, it uses an area with value **Minimum dimension \* Minimum dimension**) or if one size or both are less than the value set as **Minimum dimension**.

Pre-cut paths and/or profile changes with allocation of bridges are applied to:

- the first profile assigned as *Nesting geometry* and with *Technological priority* with value 0
- profiles assigned as *Scrap geometry* and with *Technological priority* with value 0

**Nesting geometry:** group of specific settings when applying pieces of assigned typology

- **Global technology (tec\..):** select an option among the global available technologies to be used to perform geometric profiles. If no assignment is performed, it uses the already assigned technology for executing cuts. The technology is used under resetting of the properties: construct, profile extrusion
- **Tool compensation:** select to activate the correction application to geometric profiles. The profile marked as *Nesting geometry* has external correction, profiles marked as *Scrap geometry* have inner correction
- **Pre-cut:** select to activate the functionality, as mentioned above. If the option **Minimum area** (see below) is enabled, profiles according to the area are identified for the application. The function application uses the settings of the **Pre-cut** group
- **Apply bridges to profile:** select to enable the functionality. If the option **Minimum area** (see below) is enabled, profiles according to the area are identified for the application. The function application now changes the programmed profile/profiles, with distribution of bridge points. The function application uses the settings of the **Apply bridges to profile** group. If also a pre-cut is generated for a profile, the ascent depth of the bridges corresponds to the residual thickness of the pre-cut
- **Minimum area:** select to require the application of the previous settings according to evaluations of minimum area. A piece is considered "small" if its area is less than the value set in the **Pre-cut** group in the field **Minimum area** (if the value is null, it uses an area with value **Minimum dimension \* Minimum dimension**) or if one size or both are less than the value set as **Minimum dimension**.

## 11.7 Enable

- **"Csv" file line format:** this table sets the meaning of the fields for the list file which can be selected when assigning a nesting project. The format of a list file is generally listed as CSV, i.e. a text file used for assigning a data table. Each line of the file corresponds to a row of the table and is in turn divided into fields

(individual columns) through a separator character. The setting must assign the meanings of the fields and this is done through a table row divided into 26 columns marked by letters from 'A' to 'Z'. Each field can assign an abbreviation to a specific piece of information.

As a separator between fields ';' (semicolon) or ',' (comma) is recognized.

We recommend the use of a period ('.') and not a comma (',') as decimal marker of non-integer numeric fields.

In non-numeric fields (e.g.: program description, r variables), we recommend not using the characters in use as separators between fields, i.e.: ';' (semicolon) or ',' (comma).

A list file can be generated, for example, by a design application program of *cabinets*.

Let us see what is significant to set up in a cell:

- ✓ v non-significant field
- ✓ e row activation (it interprets: 1/0, yes/no, on/off, true/false) – (default=1)
- ✓ l, h, s piece dimensions (l=length, h=height, s=thickness)
- ✓ lu, hu, su piece dimension + unit (e.g.: "500 mm").
- ✓ u unit (it interprets: 0/1, "mm"/"in") – (default=0)
- ✓ n quantity (0-999) – (default=1)
- ✓ f filename (if not assigned, it inserts a rectangle) – (default=""). If assigned in a manual cluster definition line, it represents the cluster name.
- ✓ fs filename OR thickness (if the value is numeric, it interprets thickness and inserts a rectangle) – (default="")
- ✓ d program description – (default="")
- ✓ g panel grain (it interprets: 0/1/2) – (default=0)
  
- ✓ et, eb, el, er panel edges. It interprets a string for each field, e.g.: "W11.AB67C" – (default="")
- ✓ m material (it interprets a string, e.g.: "MELAMINE") – (default="")
- ✓ ms material + thickness (e.g.: "FLBL18"=material + thickness) – (default="")
- ✓ r possibility of rotation. The value can be 0= no rotation, 1= rotation in 90° steps, 2= "Any" rotation (rotation in steps of a considerable angle defined in Nesting configuration) or can enable rotation in 90° steps or disable rotation when values are set: yes/no, on/off, true/false) – (default=0)
- ✓ x request for x mirroring (it interprets: 1/0, yes/no, on/off, true/false) – (default=0)
- ✓ p priority (0-100) – (default=0)
- ✓ n1 order reference (it interprets a string) – (default="")
- ✓ a1-a10 order reference (it interprets a string) – (default="")
- ✓ v public <r> variable list of the program to be assigned – (default=""). The field is only significant when a (\*.TCN) file is read.
- ✓ c cutting profile option. The field is only significant when a (\*.TCN) file is read.
- ✓ cl definition of the piece position, rotation and mirror within a manual cluster. It is a string composed as follows: Cluster ID#offset x#offset y#mirror#rotation angle.  
Values are separated by the # (hash) character.  
ID: identifier of the cluster  
Offset x, offset y: x and y coordinate of the lower left corner of the bounding box with respect to the zero of the coordinate axes.  
Mirror: mirror. 0=no mirror, 1 = mirror x; 2 = mirror y; 3 = mirror xy  
Rotation angle: rotation angle of the part.  
The field is significant only if manual cluster management is enabled in the nesting configuration
- ✓ idc cluster ID. If idc defines a cluster ID in the part definition ("cl" column), the row parameters refer to the cluster. For example, a material can be associated if the "m" column is defined, a thickness if the "s" column is defined and so on for the other parameters. The field is significant only if manual cluster management is enabled in the nesting configuration.
- ✓ b1, b2, b3 name of the image file with full path to be inserted into the label. The nesting label must have configured the elements representing images (see chapter **Label Wizard**). Up to 3 images can be defined.

Below, a possible example of how a row of the file can be assigned:

```
"1;1764;597;1;LEFT SHOULDER;FLBL18;;;1-LEFT SHOULDER-597x1764.DXF"
```

and how the row prototype can be assigned: "e;l;h;n;d;ms;;;f".

Another example of possible manual cluster assignment lines:

```
0;400;300;80;;drawer.tcn;;1#444.0#125.0#0#90;"Top";"Bottom";"Left";"Right";;90;1  
0;200;150;80;;drawer2.tcn;;1#101.0#138.0#1#0;
```

```
33;;;150;80;;Clustermanual;1;"T";"B";"L";"R";2;2;1
```

and the row prototype: "n;l;h;s;d;f;idc;cl;et;eb;el;er;m;r,x"



While assigning the table, it is possible to call a quick help of the significant fields.

The field with *filename* type must assign a single file name complete with extension and the file is to be found in the same list file.

A list file row is significant if it assigns:

- ON row enable
- a significant field with *filename* type (that is: the file exists) or, with *filename* not assigned,
- L and H dimensions not null.

In the first case, the element will be assigned with **Panel (\*.TCN)** type; in the second case **Rectangle**.

If the piece type **Panel (\*.TCN)** is not enabled (see **Page->General Options**): only the rows that assign valid dimensions (L, H) can be assigned.

The type of indicated files must be homogeneous:

- directly of *Panel (\*.TCN)* type, or
- corresponding to a format that can be imported (example: \*.DXF, ISO file). In this case the import module is automatically recognized.

The piece dimensions assigned to the list file can modify those of the TCN program (original or imported), with some limitations:

- if assigned as valid (positive value  $\geq \text{epsilon} * 10.0$ ) the thickness assigns that of the TCN program
- if assigned as valid (positive value  $\geq \text{epsilon} * 10.0$ ) the dimension length or height, assigns that of the TCN program, if the format import has not taken place, otherwise under direct confirmation.

The unit of measurement is applied only in the case of assignment of **Rectangle** (if the field is not assigned, the value used corresponds to the unit of measurement of the project of Nesting in use).

For the enabling fields (e, r, x) with a non-empty string assigned, this must correspond to one of the enabling values ("1", "yes", "on", "true"): on the contrary, it interprets value 0=off.

The assignment of the program description (field: 'd') is ignored in case of (\*.TCN) file.

The assignment of *material* is maintained if the setting is

- numerical with valid value in the list of assigned materials, otherwise
- string correspondent to one of the material names assigned

(see **Page ->General Options**).

The assignment of *<r> variables* is only maintained in case of reading of a (\*.TCN) file and if no formal verification is executed on the string. The field syntax is described in the chapter **Format of a file (.ncad)**. Here is an example of assignment: "#0=12 #1=20 #12=ab~c".

The assignment concerning the cutting profile is only maintained when a (\*.TCN) file is read. If the column is not assigned or if the field of a row is not assigned, it interprets value 1=on.

- **Miscellaneous procedures:** group of settings related to heterogeneous activations
- **Step-by-step solution:** select to enable the functionality of step-by-step solution applied to a rectangular nesting. When the selection is active, you can proceed to determine the nesting project solution through next evaluations of all the solutions found, in order to choose manually the best one.
- **Save the execution list:** select to enable the **Save the execution list** menu command (save a ".XMLST" file for the WSC application program)
- **Add programs to complement:** select to enable the composition of the execution list including the *Complementary programs*. The actual application of the selection depends on the creation of the same programs.
- **Nesting-flip:** select to enable the corresponding functionality, which also requires a specific HW key activation. Face 2 (bottom) management must also be active and the face geometry must correspond to absolute Cartesian system (left).  
This function enables the management of nesting placements on faces 1 and 2 (top and bottom) of the sheets, assigning the original programmed workings on both faces in a single panel.  
Face 1 (top) remains the *cutting face* of the nested parts, with consequent activation of the management concerning the assignment and sorting of all the cutting profiles.

Programmed workings on side faces (recoverable in the **Complementary programs**) are excluded however from the panels of a nesting

- **Overturn the piece:** select the overturn applied to the piece in Nesting-flip mode. The working of a panel generated in Nesting-flip mode can include a single machine or a line (of 2 or more machines). In both cases the panels must be overturned to allow working on opposite faces:
  - first face 2
  - upon completion, face 1.

The overturning of the panel can take place along a vertical or horizontal axis



- **Overturn the piece in graphic area:** information about how the piece is flipped in Nesting-flip mode in TpaCAD is used to assign the graphic display of face 2. If the option is disabled, the piece is displayed in transparency, otherwise the piece is flipped according to the setting of the **Overturn the piece** option.
- **Label on bottom face:** if the option is enabled and label management is enabled, the labels are automatically generated on face 2 (bottom). If there are already labels on face 2 (bottom), they are maintained.

If the option is not enabled and label management is enabled, the labels are automatically generated on face 1 (top). If there are already labels on face 1 (top) of a piece, they are maintained. Default option is not enabled.

- **Reports:** configuration set on the management of **Reports** (\*.XML" or \*.PDF" format)
  - **Enable:** select to enable the menu commands.

The remaining assignments concern the management of the reports under print format (example: \*.PDF"):

- **Identify the pieces (ID):** select to show this piece of information for each single placement
- **Consecutive numbers of the pieces (#):** select to show this piece of information for every single placement
- **A4 sheet size preview:** the selection refers to the generation of the Reports and requires to be able to fully exploit a page of the report, for the graphical representation of a sheet.
- **Select printer (PDF):** select one of the listed printers as the printer to use to print the report in PDF format.

- **Labels:** block of the settings relating to the label control
  - **Enable:** select to enable the label control. The activation is forced as non-active, if the [BARCODE] Barcode working is not available.
  - **Automatic font scale:** select to require the automatic resizing of the height of the font used in creating the labels, in case the representation of an inscription comes out of the area assigned during the label configuration.
  - **Label layout:** click the icon  to open the window where the XML extension files, stored in the (tpacadcfg\custom\nesting) configuration folder, are shown: the operator is requested to select a file in the assigned folder. The file must match a configuration file for the labels. It is also possible to assign a name of non-existing file: closing the window with confirmation, the file itself is created. The actual management of the labels requires the assignment of a file for a valid layout, in the terms mentioned below.
  - **Background image:** click the icon  to open the window where the image files, stored in the (tpacadcfg\custom\nesting) configuration folder, are shown: the formats that are recognized as valid are \*.PNG, \*.JPG, \*.BMP and the operator is required to select a file in the assigned folder. The selected image is used as background image of the label layout. It is an unnecessary selection.
  - **Label Wizard:** opens a window in the label wizard, opening the file assigned in the **Label layout** (see following paragraph)
  - **Select printer:** select one of the listed printers as a predefined printer to be used for the labels.
  - **Optimize the creation of labels:** select to require the record of the minimum label number. The optimization procedure records only one label for all similar applications of a program. The item is visible only if the optimized procedure is applicable. According to the layout defined for the label, this one cannot include elements that make it unique, such as displaying the part position reference in the sheet. With active selection, the assignment and position of the indicated fields do not follow the rotation of the piece.
  - **Create labels for external rotation:** select if the mechanical placement of labels on sheets manages their rotation. The selection is significant only in cases of rotated placement and concerns the fields subject to change following the application of rotation of a placement. With active selection, the assignment and position of the indicated fields do not follow the rotation of the piece. The subsequent positioning of the label, with rotated application, automatically repositions the identifying fields of the

edges aligned with the sides of the panel. With selection not active, the assignment and position of the indicated fields are adapted so as to be aligned with the sides of the panel with label positioning without rotation:

- edge identification fields
- ID\_IMAGE field (image corresponding to the single placement).
- **Create the image of the rotated label:** select if the mechanical placement of the labels on the sheets does not allow their rotation, so as to require the storage of the rotated labels (image file). This selection is significant only if square labels are assigned (with same dimension of height and width), in addition to the fact that the previous item must not be selected.  
The active selection of the field leads to the assignment of labels similar to those created when the option **Create labels for external rotation** is activated: in this case the rotated label is stored in the image file.

## 11.8 Label Wizard

The window defines the layout of the labels in accordance with the selections made at the entries:

- **Label layout**
- **Background image**

The figure shows the case of a layout already assigned, loading a background image:

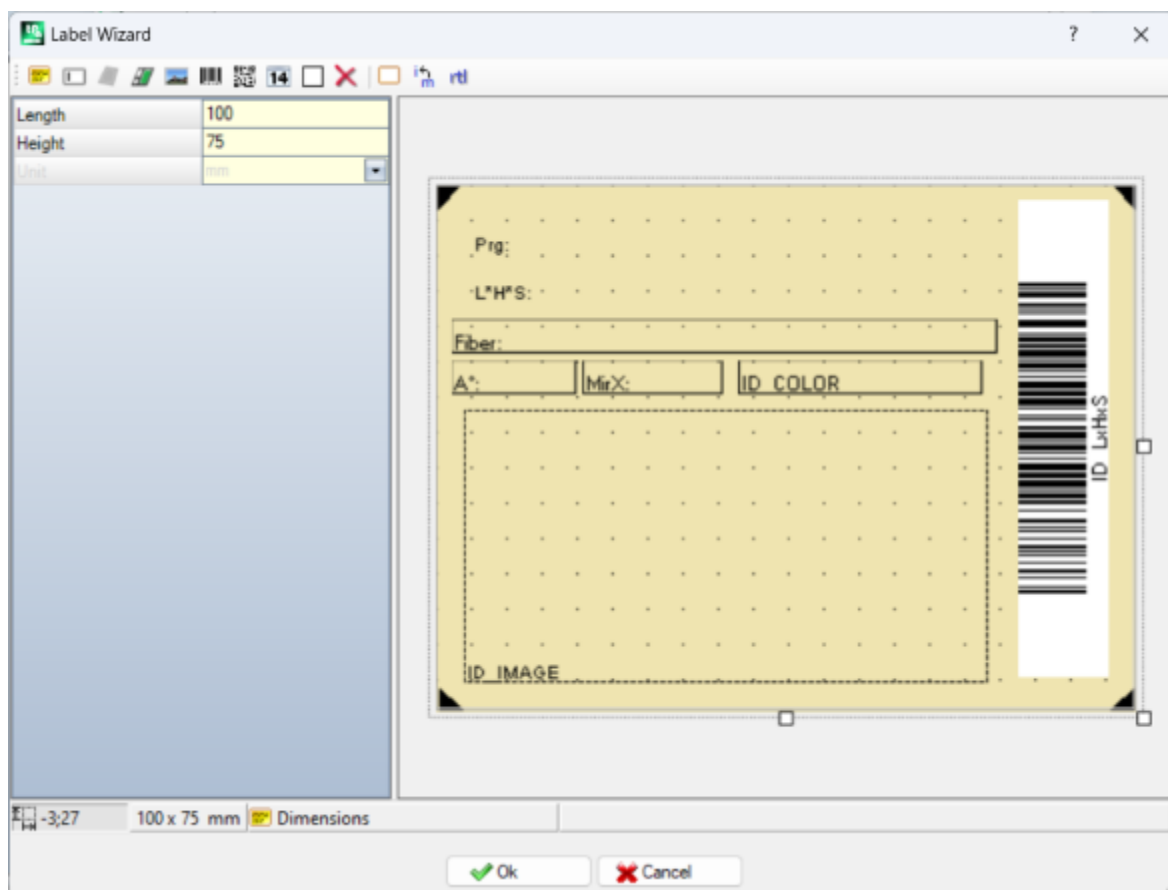

The figure is an example of a label created by applying the provided layout:

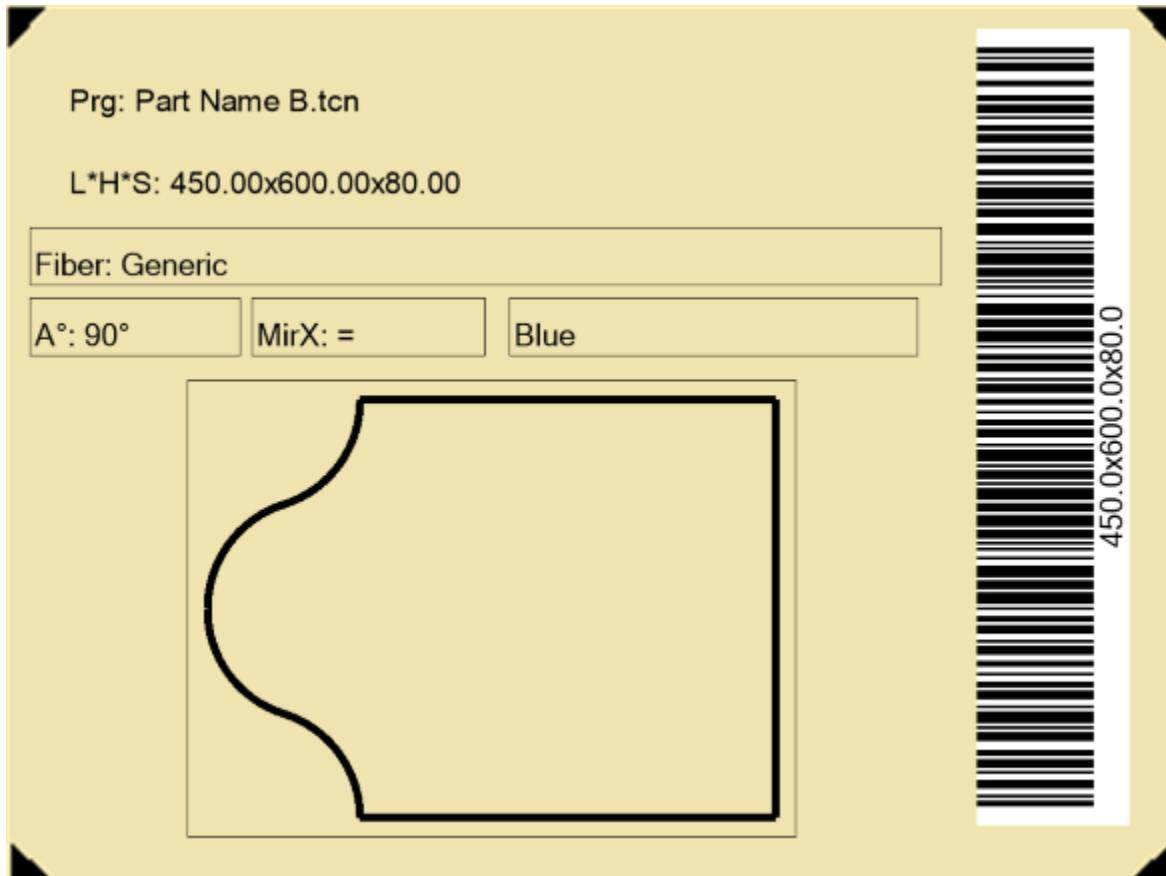

A label layout corresponds to the insertion of the fields of selected type among text, preview of piece or sheet, barcode, QR code, date and frame.

Each field has:

- a localization within the label area: position (X,Y) and dimensions (Length, Height), in label unit ([mm] or [inch])
- the possibility to be surrounded by an edge
- a characterization relating to the information to be represented (ID)
- selections added according to the field type.

The minimum dimension of a field corresponds to 5 x 5 pixels.

Each field creates an image to be positioned in the label.



The IDs can be selected into a list of significant values; ID=0 corresponds to a non-assigned value.

List of the values:

ID_ORDER	shows the project information that corresponds to the Order Reference (example: name of the customer and/or order and/or order number)
ID_PRODUCT	shows the information of the project corresponding to the Product (e.g.: product and/or model)
ID_DATE	shows the date in a format corresponding to the computer culture
ID_IMAGE	requires the graphic representation of the single piece with the applied workings
ID_SHEET_IMAGE	requires the graphic representation of the sheet with all the positionings and highlights the positioning of the current piece [note 1]
ID_NAME	shows the name of the TCN.file corresponding to the single positioning
ID_NAME2	shows the name of the TCN file corresponding to the program once completed (the field assignation does not verify if the file actually exists)

ID_DESCR	shows the comment of the TCN file corresponding to the single positioning
ID_LxHxS	shows the dimensions of the positioned piece in the format Length x Height x Width (in the example: 450x600x80)
ID_LxH	shows the dimensions of the positioned piece in the format Length x Height
ID_L	shows the length of the piece (in the example: 450)
ID_H	shows the height of the piece (in the example: 600)
ID_S	shows the thickness of the piece (in the example: 80)
ID_UNIT	shows the program unit of measure ("mm" or "inch")
ID_PRGORDER	shows the information of the single piece corresponding to the Order Reference (example: client name and/or order and/or order number), or to Added Info (see: assignment in Formatting string)
ID_ROTATE	shows the indication of the positioned rotated piece (in the example: 90°)
ID_MIRROR	shows the indication of a piece to be made mirrored (in the example: no)
ID_EDGE_TOP	shows the indication of the Piece edge code applied to the top side (face 5)
ID_EDGE_BOTTOM	shows the indication of the Piece edge code applied to the bottom side (face 3)
ID_EDGE_LEFT	shows the indication of the Piece edge code applied to the left side (face 6)
ID_EDGE_RIGHT	shows the indication of the Piece edge code applied to the right side (face 4)
ID_FIBER	shows the indication of the material for the panel (in the example: "Generic")
ID_COLOR	shows the indication of the colour for the panel (in the example: "Blue")
ID_SHEET_ID	shows the identifier (ID) of the sheet [ <i>note 1</i> ]
ID_SHEET_COUNT	shows the consecutive number of the sheet ("1" corresponds to the first number of the solution; "2" to the second, etc) [ <i>note 1</i> ]
ID_ROW_COUNT	shows the consecutive number of the current positioning (on the sheet) [ <i>note 1</i> ]
LABEL_*	shows the value of the parameter corresponding to the <b>Label-BARCODE</b> working of the single positioning. The entry in the list consists of "LABEL_name", where (name) is the ASCII parameter name
ID_RECT	shows a rectangle, either full or just its edge representation
NONE (=0)	corresponds to a not assigned ID: it can be used in the field type "Text" to show a fixed text.

[*note 1*] the use of this field forces the creation of the labels by means of a non-optimized procedure.

	<p>It sets the dimension of the label, in unit [mm] or [inch]. In the figure: 100*75 mm. Minimum dimension: 20 x 20 pixels (1 mm corresponds to 3.78 pixels, that is 1 pixel corresponds to 0.265 mm).</p> <p>A <u>background image</u> is loaded until it reaches the maximum dimension of the label.</p>
	<p>Select to insert a "Text" file. The type is selected in the ID list.</p> <p>Additional selections of the field:</p> <ul style="list-style-type: none"> <li>• <b>Title:</b> text to be used as a field header</li> <li>• <b>Default value:</b> text to be shown as a value, if the field is not found</li> <li>• <b>Position:</b> alignment of the overall text (Title &amp; Value) in relation to the overall rectangle of the field</li> </ul> <p style="text-align: center;">         TopLeft      TopCenter      TopRight          BottomLeft    BottomCenter    BottomRight       </p> <ul style="list-style-type: none"> <li>• <b>Font:</b> writing font</li> <li>• <b>Height:</b> in pixel units (minimum: 5)</li> <li>• <b>Colour:</b> writing colour of the text</li> <li>• <b>Bold, Italics, Underlined:</b> selections for the font</li> <li>• <b>Rotation:</b> specifies the rotation of the field and the axis used to turn the representation upside down (see: "Barcode")</li> </ul>

In the field preview the text corresponding to "Title: Default value" is reported; if a Default value is not assigned, a numerical value of the ID is written.

- **Formatting string:** assigns a formatting and/or a conditioning and/or a field indexing.

### **Formatting**

The recognition arises with first character '=' (character: hash). The formatting concerns information of decimal (double) or integer or string type number.

A number type example is a piece dimension (ex: ID= ITEM\_L).

It is possible to assign a formatting for the fields with ID:

- ITEM\_LxHxS, ITEM\_LxH, ITEM\_L, ITEM\_H, ITEM\_S
- LABEL\_\*

Examples of valid formatting ('#' is omitted):

"D6" formats an integer value on 6 digits (example: 12 >"000012")

"F01" formats a double value with 1 decimal digit (example: 1234.678 >"1234.6")

"F03" formats a double value with 3 decimal digits (example: 1234.678 >"1234.678").

If the assignment is not valid, proceed with the usual formatting without any warning.

A string type example is the comment of the TCN file (ID\_DESCR).

It is possible to assign a formatting for the fields with ID:

- ID\_DESCR, ID\_ORDER, ID\_PRODUCT
- LABEL\_\*

The formatting action is valid if is as follows: "#n", with n= positive number = maximum number of given characters. Characters exceeding the maximum given length are deleted.

A particular case of string type is ID\_NAME, field that shows the file path corresponding to the single placement and to which a more specific formatting can be assigned.

In case of rectangle placement, the name does not correspond to any file and it is automatically assigned: in this case the single general formatting of string can be recognized (example: "#10").

A similar case is ID\_NAME2, a field that shows the completion file path.

On the contrary, we now examine the case where the name corresponds to a file:

- ✓ without any specific formatting, the path name *related* to the program folder is shown, included the extension (example: "TEST\_NESTING\AAA.TCN")
- ✓ through a standard formatting it is possible to edit its visualization.

It is possible to specify the path part that is wanted to be shown in the label, differentiating among folder addressing, file name and extension. The formatting is valid if it is "#p\n.x", where:

- ✓ "p" character to activate the *folder*: "\*" or activates, "0" deactivates
- ✓ "n" character to activate the *file name*: "\*" activates, "0" deactivates
- ✓ "x" character to activate the *file extension*: "\*" activates, "0" deactivates.



We now see how to apply the formatting in specific, always in the example



























"test\_nesting\aaa.tcn":

- ✓ "#0\\*.0", "#0\\*": shows the name without extension: "aaa"
- ✓ "#0\\*. \*": shows the name with extension: "aaa.tcn"
- ✓ "#\*\0.0", "#\*\0", "#\*\": shows the single absolute path: "C:\ALBATROS\PRODUCT\TEST\_NESTING"
- ✓ "#\*\\*.0", "#\*\\*": shows the absolute path and its name without extension: "C:\ALBATROS\PRODUCT\TEST\_NESTING\AAA"
- ✓ any other assignment: it does not apply the formatting.







Another particular case of formatting can regard the assignment of fields that identify one side of the single piece. The operation can take place by using:

- parameters of the working **Label-BARCODE** (list entries as "LABEL\_name")
- fields of ID\_RECT type
- fields that identify an edge (ID\_EDGE\_TOP, ID\_EDGE\_BOTTOM, ID\_EDGE\_LEFT, ID\_EDGE\_RIGHT)

	<p>For instance, placing the fields around a field like "Graphics of the single piece" (ID=ID_IMAGE) or on the label edges, and assigning significant formatting:</p> <ul style="list-style-type: none"> <li>• "#edger" to identify the right side of the piece</li> <li>• "#edgel" to identify the left side of the piece</li> <li>• "#edget" to identify the top side of the piece</li> <li>• "#edgeb" to identify the bottom side of the piece</li> </ul> <p>In case of placement of a piece with rotation and/or mirror, the fields <i>follow</i> the piece. In this way, it is possible to highlight each one of the four sides of the piece in the label, regardless of how it is positioned on the sheet.</p> <p>In case of use of the fields identifying an edge (ID_EDGE_TOP, ID_EDGE_BOTTOM, ID_EDGE_LEFT, ID_EDGE_RIGHT):</p> <ul style="list-style-type: none"> <li>• assigning the "#edge" formatting is enough: the edge side is implicit in the used ID</li> <li>• the same programmed edge code is shown on the label.</li> </ul> <p style="text-align: center;"><b><u>Conditioning</u></b></p> <p>The recognition arises with first character = '?' (character: question mark) and can lead to the exclusion of the field in the label. You can apply the recognition in the event of TCN program Nesting only.</p> <p>Recognized characters (after '?') are:</p> <p>'s' = must verify that in the original program there are workings programmed in faces other than the face of nesting (upper face)</p> <p>!s' = must verify that the original program does <u>not</u> have any workings programmed in faces other than the nesting face (upper face)</p> <p>r' = must verify that the workings of the program have been excluded in Nesting solution</p> <p>!r' = must verify that the workings of the program have <u>not</u> been excluded in Nesting solution</p> <p>&amp;' = is applied in a "logical and" condition among all the given conditions: only if all the conditions are verified, the field is given in the label. Otherwise, a "logical or" condition is applied.</p> <p>v' = must verify that the field is assigned (that is: value different from 0 for integer field, assigned string for string field)</p> <p>!v' = must verify that the field is <u>not</u> assigned</p> <p>The condition of field assignment is assessed regardless of the others settings (condition of "logical and").</p> <p style="text-align: center;"><b><u>Indexing</u></b></p> <p>Recognition is triggered with first character = '%' (character: percent). Recognition is currently only applied to the field:</p> <ul style="list-style-type: none"> <li>• ID=ID_PRGORDER: allows managing the Added Info of a single piece, by assigning the corresponding value to the field (from 1 to 10).</li> </ul> <p>Example: "%3" reports the third added information, as assigned for the single piece. It is recalled that the added information is generically strings.</p> <p>An assignment of this type can be set together with the others examined here.</p> <p>Example: "?v%5".</p> <p><b><u>Conditioning + Formatting</u></b></p> <p>You can set both assignments.</p> <p>Example "?sr?v#0\*.*)"</p>
	<p>Select to insert a "Graphics of the single piece" field. The type is ID=ID_IMAGE and in the layout of the label it is possible to assign only one field with this type.</p> <p>The field assigns: position (X,Y), dimensions (Length, Height).</p> <p>The field requires the graphic representation of the workings applied to the piece; like in the figure: a door profile rotated 90°.</p>
	<p>Select to insert an "Overall graphics of the sheet". The type is ID=ID_SHEET_IMAGE and in the layout of the label you can assign only one field of this type.</p>

	<p>This field assigns position (X,Y), dimensions (Length, Height), rotation.</p> <p>This field requires the graphic representation of the sheet with all the placements and the placement highlighted of the current piece.</p>								
	<p>Select to insert an image. Two types of images can be set: static and dynamic. The static image is unique for all the labels. The image file is chosen in the <b>Label Wizard</b> and cannot be modified except in the <b>Label Wizard</b> itself. The dynamic image is defined in the <b>Label Wizard</b>, but can be reassigned in every program. To make the image dynamic, <b>Formatting string</b> field must be filled in according to the rules described below. Up to maximum 3 dynamic labels can be set. Type is ID=ID_IMGCUSTOM. Data to define the image field is as follows:</p> <ul style="list-style-type: none"> <li>• <b>X, Y</b>: position of the top left corner of the image overall rectangle</li> <li>• <b>Length, Height</b>: dimensions of the image overall rectangle</li> <li>• <b>Edge</b>: select to display an edge around the image</li> <li>• <b>Image</b>: click on the icon  to open the image file selection window. Valid recognized formats are *.PNG, *.JPG, *.BMP. Only images saved in the configuration folder TPACADCFG\CUSTOM\DBIMAGE can be uploaded.</li> <li>• <b>Formatting string</b>: if the field is filled in, the image is identified as dynamic. Values to be set are b1 for the first image, b2 for the second image, b3 for the third image. Fields other than these values have no meaning.</li> <li>• <b>Rotation</b>: rotate the image to 90° steps with or without mirror.</li> </ul>								
	<p>Select to insert a "Barcode" type field. The type is selected in the ID list. Additional selections of the field:</p> <ul style="list-style-type: none"> <li>• <b>Code</b>: select a code in the list (for the description of the different types of barcodes, please read the specific documentation)</li> <li>• <b>Default value</b>: text to be shown as a value, if the field is not found</li> <li>• <b>Display text</b>: select to view also the representation in text format</li> <li>• <b>Position</b>: position of the text with respect to the barcode (when <i>Display text</i> is selected)</li> <li>• <b>Rotation</b>: below the visual effect based on the selection made (in all the examples the text is also displayed, with alignment by default "BottomCenter")</li> </ul> <table border="1" data-bbox="459 1169 1362 1883"> <tr> <td data-bbox="459 1169 927 1312">                     RotateNoneFlipNone                        600x450x80                 </td> <td data-bbox="927 1169 1362 1312">                     RotateNoneFlipXY                        08x024x003                 </td> </tr> <tr> <td data-bbox="459 1312 927 1456">                     RotateNoneFlipX                        08x024x003                 </td> <td data-bbox="927 1312 1362 1456">                     RotateNoneFlipY                        08x024x003                 </td> </tr> <tr> <td data-bbox="459 1456 695 1883">                     Rotate90FlipNone                        600x450x80                 </td> <td data-bbox="695 1456 904 1883">                     Rotate90FlipXY                        600x450x80                 </td> <td data-bbox="904 1456 1129 1883">                     Rotate90FlipX                        08x024x003                 </td> <td data-bbox="1129 1456 1362 1883">                     Rotate90FlipY                        08x024x003                 </td> </tr> </table> <p>A "Barcode" type field will be actually shown in the label only with corresponding value assigned: so, you need to select a significant ID.</p>	RotateNoneFlipNone  600x450x80	RotateNoneFlipXY  08x024x003	RotateNoneFlipX  08x024x003	RotateNoneFlipY  08x024x003	Rotate90FlipNone  600x450x80	Rotate90FlipXY  600x450x80	Rotate90FlipX  08x024x003	Rotate90FlipY  08x024x003
RotateNoneFlipNone  600x450x80	RotateNoneFlipXY  08x024x003								
RotateNoneFlipX  08x024x003	RotateNoneFlipY  08x024x003								
Rotate90FlipNone  600x450x80	Rotate90FlipXY  600x450x80	Rotate90FlipX  08x024x003	Rotate90FlipY  08x024x003						



	<p>Select to insert a "QR code" type field. In the label layout it is possible to assign only one field with this type.</p> <p>The field assigns:</p> <ul style="list-style-type: none"> <li>• <b>position</b> (X, Y)</li> <li>• <b>dimension</b> (Length): Height is automatically assigned to the same value.</li> </ul> <p>Information to be written in the QR code field is easily identified; the fields concerned must assign the <i>Title</i> attribute as:</p> <ul style="list-style-type: none"> <li>• <b>"qr"</b>, or <b>"qr:"</b></li> <li>• <b>"qr:title"</b> where <i>title</i> assigns the field name that is reported in the QR code.</li> </ul> <p>However, the following fields are excluded:</p> <ul style="list-style-type: none"> <li>• <i>rectangle</i> or <i>barcode</i> type</li> <li>• code corresponding to an <i>edge</i> of the piece (for example: ID_EDGE_TOP), if placement formatting on the label is assigned.</li> </ul> <p>The fields concerned are written only in the QR code. Information formatting respects the syntax:</p> <pre>{"title1":"value1","title2":"value2",...,"title_n":"value_n"}</pre> <ul style="list-style-type: none"> <li>• opening and closing curly brackets</li> <li>• individual fields separated by commas (,)</li> <li>• structure of each field: "title": "value" (double quotes are actually shown in the formatted string)             <ul style="list-style-type: none"> <li>▪ <i>title</i>: is the name (or title) of the field</li> <li>▪ <i>value</i>: is the value assigned to the field (in string format).</li> </ul> </li> </ul> <p>Fields to which empty <i>value</i> is assigned are omitted.</p> <p>Below is an example of a QR code, with 5 fields assigned:</p> <pre>{"ID_ORDER":"ABC-ref.145","name":"b.tcn","dims":"450.0x600.0x80.0","material":"Generic","ID_ORDER1":"macGTR"}</pre> <ul style="list-style-type: none"> <li>• <b>"ID_ORDER": "ABC-ref.145"</b>: type field ID_ORDER with <i>Title</i>="qr" (the field name is automatically assigned to the identifying string of the field itself)</li> <li>• <b>"name": "b.tcn"</b>: type field ID_NAME with <i>Title</i>="qr: name"</li> <li>• <b>"dims": "450.0x600.0x80.0"</b>: type field ID_LxHxS with <i>Title</i>="qr: dims"</li> <li>• <b>"material": "Generic"</b>: type field ID_FIBER with <i>Title</i>="qr: material"</li> <li>• <b>"ID_ORDER1": "macGTR"</b>: type field ID_ORDER with Formatting string="%1" and <i>Title</i>="qr" (the field name is automatically assigned to the identification string of the same field)</li> </ul>
	<p>Select to insert a field as <i>Date</i>. The type is ID=ID_DATE and it is possible to assign only one field with this type in the label layout.</p> <p>The assignment of the field is similar to a type field as "Text"</p>
	<p>Select to insert a <i>Rectangle</i> type field.</p> <p>The field assigns:</p> <ul style="list-style-type: none"> <li>• <b>position</b> (X, Y) and <b>dimensions</b> (Length and Height)</li> <li>• <b>edge</b>: select the item to show an empty rectangle, or the rectangle will be shown full</li> <li>• <b>colour</b>: colour applied to the edge or to the internal area</li> <li>• <b>formatting string</b>: to use for assignment such as "#edge..." (see above)</li> </ul>
	<p>Select to delete the current field</p>
	<p>Select to view an edge around each field, regardless of importing <i>Edge</i> of the field itself</p>
	<p>Only one of the buttons is displayed, according to the programming unit of the label:</p> <ul style="list-style-type: none"> <li>• unit [mm]:  converts in [inch]</li> </ul>

	<ul style="list-style-type: none"> <li>unit [inch]:  converts in [mm]</li> </ul>
<b>rtl</b>	Select the button to require the label layout from right to left

The layout is recognized as valid for the composition of the label files, if:

- the label dimension is at least 20 x 20 pixels
- valid fields are assigned, that is:
  - position is inside the label
  - with a minimum dimension of 5 x 5 pixels
  - with ID assigned as significant (>0), or
  - with ID=0 and significant **Title** and/or **Default value**.

## Example of label with edges indicated

Below is an example of a label where the edge information is indicated:

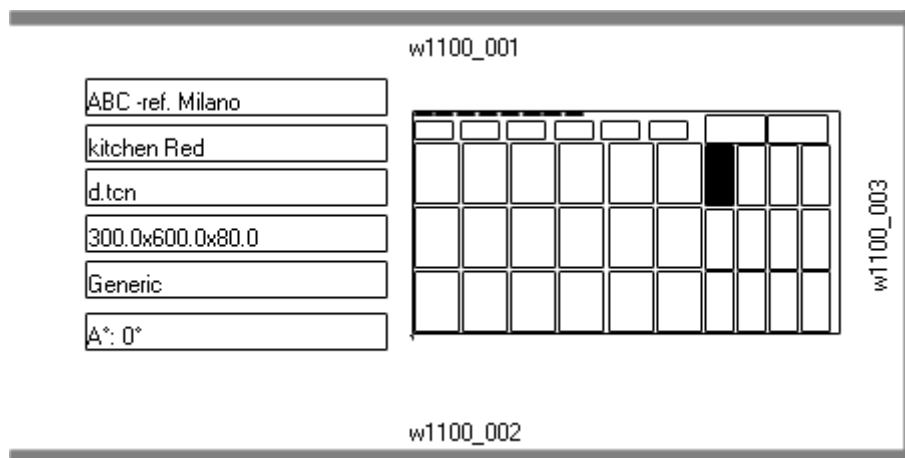

- a field of "Complete graphic of the sheet" (ID\_SHEET\_IMAGE) is shown on the right: the black tile shows the corresponding placement
- the information of the configured edges is on the sides of the label. Here: all, except the left side.
- each edge shows: a solid tile and the text corresponding to the edge code (for illustrative purposes, different codes were used).

Let us see how to assign the fields so that the representation on the label follows the placement of each piece, with an eventual rotation and/or mirror. For instance, we shall analyze the fields of the top edge:

- field of type ID\_RECT, formatting string=?v#edget
  - "?v": it conditions the representation of the field assignment, which is identified by the formatting string ("#edget"): it assesses the information corresponding to ID\_EDGE\_TOP
  - "#edget": it associates the field to the position corresponding to the top edge of the current placement
- text fields: ID=ID\_EDGE\_TOP, formatting string =?v#edge
  - "?v": it conditions the representation of the assignment of *Top edge* of the current placement
  - "#edge": it associates the field to the position corresponding to the top edge of the current placement

The result brings to:

- excluding the representation of the two fields, if the corresponding piece does not set a code for *Top edge* (as in the figure: "w1100.001")
- adjusting the position of the fields according to the placement mode, but only if the configured fields correspond to all the edges. E.g.: with a placement rotation of 90°, the information will be displayed on the left side of the label, corresponding to the field ID\_EDGE\_LEFT.

The assignment of the field ID\_EDGE\_TOP without formatting string ("#edge") excludes the adjustment of the position according to the placement mode.

The figure can correspond to a sheet with placement of different pieces:

- the numbering shows the *Consecutive numbers of the pieces*
- the graphic elements corresponding to the configured edges are evident.



The label shown above can correspond to the placement of progressive #21.

Below is the label that corresponds to the progressive #25: same piece, but now the placement is rotated. It is evident how the edge representations were switched.

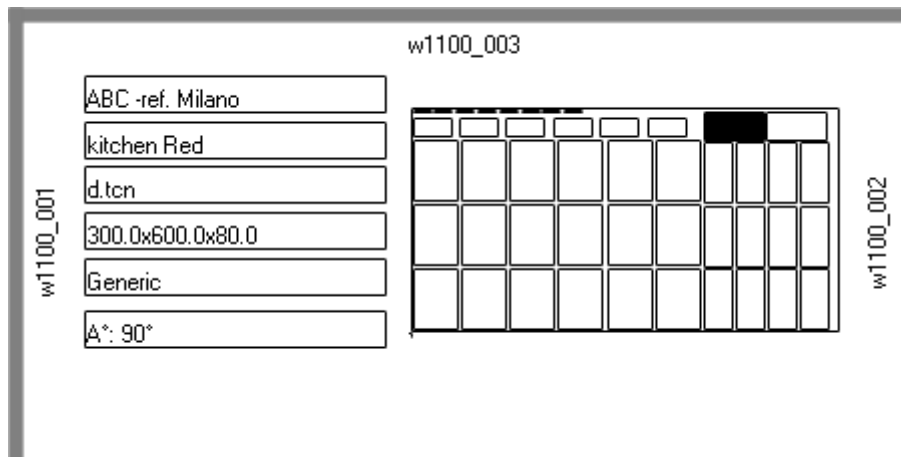

### Example of label with QR code

Below is a different version of the first label shown in the previous paragraph, with the fields on the left side formatted in the QR code field:

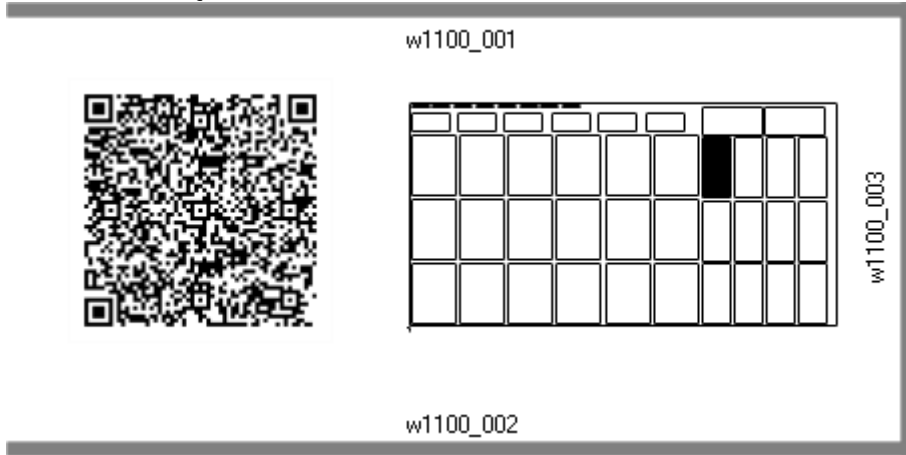

## 12 Nesting in Demo mode

In the Demo mode the Nesting functionality can be valued without saving the panels and the labels.

The representation of the panels excludes the development of the cutting paths.

## 13 Format of a file (.ncad)

This paragraph describes the syntax of a NCAD file that, as we have seen, corresponds to a nesting program.

The files have an XML format, and below you will find the base scheme.

<code>&lt;?xml version="1.0" encoding="UTF-8"?&gt;</code>	Opening row of the XML format
<code>&lt;update&gt;</code>	Opening element of the main file structure
<code>&lt;params&gt;</code>	Opening element of the Parameter unit (if available, it must be assigned as the first section. If the section is not present, the Nesting Program uses the assignment of the prototype file.
<code>&lt;param name="unit" value="0" /&gt;</code> <code>&lt;param name="mode" value="0" /&gt;</code>	Assignment elements of parameters
<code>&lt;/params&gt;</code>	Closure element of the Parameter unit
<code>&lt;rows&gt;</code>	Opening element of the Piece unit (TCN programs or rectangular shapes)
<code>&lt;row en="1" name="a.tcn" diml="450" .. /&gt;</code> <code>&lt;row en="1" name="b.tcn" diml="500" .. /&gt;</code>	Assignment elements of a single sheet
<code>&lt;/rows&gt;</code>	Closure element of the Sheet unit
<code>&lt;sheets&gt;</code>	Opening element of the Sheet unit  If the section is not present, the Nesting Program uses the assignment of the prototype file
<code>&lt;sheet en="1" diml="4200" ... /&gt;</code> <code>&lt;sheet en="1" diml="4000" ... /&gt;</code>	Assignment elements of a single sheet
<code>&lt;/sheets&gt;</code>	Closure element of the Sheet unit
<code>&lt;/update&gt;</code>	File terminator

## 13.1 Parameter Section

Let us see in detail a parameter assignment element.

An example of element is:

```
<param name="unit" value="0" />
```

where:

<code>&lt;param</code>	Element heading
<code>name="nn"</code>	specifies the name of the parameter
<code>value="vv"</code>	specifies the value of the parameter
<code>/&gt;</code>	Closing element

Below is the list of the parameters that are not interpreted.

If a parameter is not assigned, a value is used, hereinafter referred to as *{default}*.

Name	Meaning and value
"refOrder"	Order reference (customer name and/or job order and/or order number)
"refProduct"	Product reference (product and/or model)
"unit"	Unit of measure of the generated panels: 0 =[mm] <i>{default}</i> 1 (<>) =[inch]
"bLeft" "bRight" "bTop" "bBottom"	Allowance for waste of panels, left, right, high, low respectively <i>{default: 0.0}</i>
"bInner"	Internal margin <i>{default: 0.0}</i>
"direction"	Feed direction for the positionings: 0 =Horizontal <i>{default}</i> 1 (<>) =Vertical
"corner"	Starting vertex for the positionings: 0 (or <0) =Left-Bottom <i>{default}</i> 1 =Left-Top 2 =Right-Bottom 3 (or >3) = Right-Top

"order"	<p>Selection to apply the priority values set for the pieces (TCN or rectangles).</p> <p>(&gt;0) =ON 0 (&lt;=0) =OFF {default}</p> <p>This setting can be ignored according the Nesting configuration.</p>
"order_sheet"	<p>Select to apply the priority values set on the panels.</p> <p>(&gt;0) =ON 0 (&lt;=0) =OFF {default}</p> <p>This setting can be ignored according the Nesting configuration.</p>
"type"	<p>Selection to apply the correspondence of the material</p> <p>(&gt;0) =ON 0 (&lt;=0) =OFF {default}</p> <p>This setting can be ignored according the Nesting configuration.</p>
"color"	<p>Selection to apply the correspondence of the colour:</p> <p>(&gt;0) =ON 0 (&lt;=0) =OFF {default}</p> <p>This setting can be ignored according the Nesting configuration.</p>
"zeta"	<p>Select to apply the association with the thickness (in case of positioning of rectangles, this selection is irrelevant):</p> <p>(&gt;0) =ON {default} 0 (&lt;=0) =OFF</p>
"works"	<p>Selection to apply the workings of the original TCN panels in the panels of the nesting</p> <p>(&gt;0) =ON {default, if the Configuration does not exclude its management} 0 (&lt;=0) =OFF</p> <p>This setting can be ignored according the Nesting configuration.</p>
"rctmin"	<p>Selection to enable the angle of minimum overall dimension (types of piece corresponding to shapes):</p>



	(>0) =ON 0 (<=0) =OFF {default}
--	------------------------------------

## 13.2 Piece Section

Let us see in detail a piece assignment element.

An example of element is:

```
<row en="1" name="b.tcn" diml="450" dimh="600" dims="80" items="25" type="0" ang="1" mir="0" rgb="-1"
vars="" />
```

where:

<row

Element heading

en="1" name="b.tcn"...

Piece assignment fields: each assigned according to the format

name="value"

/>

Closing element

Below is the list of the fields assigning a single piece:

Name	Meaning and value
"rtipo"	Type of piece:  0 = Panel (*.TCN) {default}  1 = Rectangle  2 = Shaped workpiece  3 = Nesting geometry
"en"	Enabling status:  (>0) =ON {default}  0 (<=0) =OFF
"name"	Identifies the TCN program (with related addressing to the program folder)  The field can be ignored in case of placement of rectangles.
"diml" "dimh"	Dimensions of the piece: length, height, thickness, respectively.

"dims"	<p>Assign values <math>\geq 0.0</math> <i>{default=0.0}</i></p> <p>Placing TCN programs, they can correspond to the original or to the modified sizes.</p> <p>The thickness is ignored when rectangles are placed.</p>
"grain"	<p>Grain direction: 0=not assigned, 1=horizontal direction, 2=vertical direction</p>
"edgeT", "edgeB", "edgeL", "edgeR"	<p>Piece edges (it assigns an edge code in string format)</p>
"items"	<p>Number of the sheets to place (assign a value in the range: 0 – 999)</p> <p><i>{default=0}</i></p>
"items_max"	<p>Maximum quantity to place (assign a value in the range: 0 – 999)</p> <p><i>{default=0}</i></p>
"type"	<p>Material of the sheet (assign a value in the range: 0 – maximum number of materials assigned in the configuration).</p> <p><i>{default=0}</i></p> <p>This setting can be ignored or changed according to the Nesting configuration.</p>
"rgb"	<p>Sheet colour. Assign:</p> <p>the number corresponding to the colour or</p> <p>the name of the colour (example: "Red")</p> <p><i>{default=-1 (colour not assigned)}</i></p> <p>This setting can be ignored or changed according to the Nesting configuration.</p>
"order"	<p>Priority of the piece (assign a value in the range: 0 – 100)</p> <p><i>{default=0}</i></p> <p>This setting can be ignored or changed according to the Nesting configuration.</p>

"refRow"	Order reference of the piece
"aux1"- "aux10"	Additional info on the piece
"ang"	<p>Positioning status with rotation:</p> <p>0 (&lt;=0) =OFF= the piece cannot be rotated <i>{default}</i></p> <p>1 = the piece cannot be placed with 90° rotation.</p> <p>2 = the piece cannot be placed with rotation "any"</p>
"mir"	<p>Status of mirrored positioning:</p> <p>(&gt;0) =the piece is placed mirrored</p> <p>0 (&lt;=0) =OFF <i>{default}</i></p>
"vars"	<p>Assigning 'r' variables. The field is ignored when rectangles are placed.</p> <p>The format is assigned as: "#n1=v1 #n2=v2 #..", where:</p> <ul style="list-style-type: none"> <li>• '#': heading character for a single field of a variable</li> <li>• n1: number of the 'r' variable (from 0 to 300)</li> <li>• '=': separating character in the field</li> <li>• (v1): value of the variable (if a string, the spaces should be replaced by '~')</li> <li>• ' ' (space): separating character between the fields</li> </ul> <p>Example: "#0=12 #1=20 #12=ab~c".</p> <p>This setting can be ignored or changed according to the Nesting configuration.</p>
"rct_cut"	<p>Selection to apply the cut profile (the selection is influential only in the case of "rtipo=0" positioning):</p> <p>(&gt;0) =ON <i>{default}</i></p> <p>0 (&lt;=0) =OFF</p>
"in_isle"	<p>Selection to enable positioning within the scraps (the selection is influential only in the case of "rtipo=2.3" True Shape positioning):</p> <p>(&gt;0) =ON <i>{default}</i></p>

	0 (<=0) =OFF
"on_pair"	Select to enable the application of the automatic cluster of the piece with respect to the single positioning (the selection is insignificant only in the case of True Shape positioning of "rtipo=2,3"):  (>0) =ON  0 (<=0) =OFF {default}
"on_grid"	Select to enable the application of grid placements (the selection is significant only in case of True Shape placement of "rtipo=2,3"):  (>0) =ON  0 (<=0) =OFF {default}
"refRowA" "refRowB" "refRowC"	Names of the image files to be inserted into the label. The setting needs to have set in the <b>Label Wizard</b> an ID_IMGCUSTOM field with <b>Formatting string</b> defined according to the specifications described in the chapter <b>Label Wizard</b> .

### 13.3 Section of manual clusters

Let us see the detail of an assignment element of manual clusters.

An example of element is:

```
<group en="1" name="clust_4" dims="80" items="3" range="0" grain="1" type="1" order="1" ang="1" mir="1" rgb="Aquamarine">
```

```
<param name="item" value="1;146.077;246.532;0;0" />
```

```
<param name="item" value="2;261.877;271.095;0;0" />
```

```
</group>
```

where:

```
<group
```

Element heading

```
en="1" name="clust_4"...
```

Assignment fields of cluster assigned in format name="value"

```
/>
```

Closing element

Below is the list of the fields assigning a single cluster:

Name	Meaning and value
------	-------------------

"en"	<p>Enabling status:</p> <p>(&gt;0) =ON {default}</p> <p>0 (&lt;=0) =OFF</p>
"name"	Cluster name
"dims"	<p>Cluster thickness</p> <p>Assign value &gt;=0.0 {default=0.0}</p>
"grain"	Grain direction: 0=not assigned, 1=horizontal direction, 2= vertical direction
"edgeT", "edgeB", "edgeL", "edgeR"	Cluster edges (assigns an edge code in string format)
"items"	<p>Number of clusters to place (assign a value in the range: 0 - 999)</p> <p>{default=0}</p>
"items_max"	<p>Maximum quantity to place (assign a value in the range: 0 - 999)</p> <p>{default=0}</p>
"type"	<p>Sheet material (assign a value in the range: 0 - maximum number of materials assigned in configuration)</p> <p>{default=0}</p> <p>This setting can be ignored or changed according to the Nesting configuration.</p>
"rgb"	<p>Sheet colour. Assign:</p> <p>the number corresponding to the colour or</p> <p>the name of the colour (example: "Red")</p> <p>{default=-1 (colour not assigned)}</p> <p>This setting can be ignored or changed according to the Nesting configuration.</p>

"order"	<p>Piece priority (assign a value in the range: 0 - 100) <i>{default=0}</i></p> <p>This setting can be ignored or changed according to the Nesting configuration.</p>
"refRow"	Order reference of the cluster
"aux1", "aux10"	Added information about the cluster
"ang"	<p>Placement status with rotation:</p> <p>0 (&lt;=0) =OFF= the cluster cannot be rotated <i>{default}</i></p> <p>1 = the cluster can be placed with 90° rotation.</p> <p>2 = the cluster can be placed with "any" rotation</p>
"mir"	<p>Status of mirrored placement:</p> <p>(&gt;0) = the cluster is placed mirrored</p> <p>0 (&lt;=0) =OFF <i>{default}</i></p>
"in_isle"	<p>Select to enable placements within the scraps:</p> <p>(&gt;0) =ON <i>{default}</i></p> <p>0 (&lt;=0) =OFF</p>
"on_pair"	<p>Select to enable the application of automatic cluster of the piece with respect to the single placement.</p> <p>(&gt;0) =ON</p> <p>0 (&lt;=0) =OFF <i>{default}</i></p>
"on_grid"	<p>Select to enable the application of grid placements:</p> <p>(&gt;0) =ON</p> <p>0 (&lt;=0) =OFF <i>{default}</i></p>

## 13.4 Sheet Section

Let us see the detail of a sheet assignment element.

An example of element is:

```
<sheet en="1" diml="4200" dimh="2200" dims="80" items="5" type="0" order="0" rgb="16711680" />
```

where:

<code>&lt;sheet</code>	Element heading
<code>en="1" diml="4200" ...</code>	Sheet assignment fields: each assigned according to the format
<code>name="value"</code>	name="value"
<code>/&gt;</code>	Closing element

Below is the list of the fields assigning the single sheet:

Name	Meaning and value
"en"	Enabling status:  (>0) =ON {default}  0 (<=0) =OFF
"name"	Identifies the sheet
"diml" "dimh" "dims"	Dimensions of the sheet: length, height, thickness, respectively.  Assign values >=0.0 {default=0.0}
"grain"	Grain direction: 0=not assigned, 1=horizontal direction, 2= vertical direction
"items"	Number of the sheet to place (assign a value in the range: 0 – 100) {default=0}
"type"	Material of the sheet (assign: see element of Piece)  This setting can be ignored or changed according to the Nesting configuration.
"rgb"	Colour of the sheet (assign: see element of Piece)

	This setting can be ignored or changed according to the Nesting configuration.
"order"	Priority of the sheet (assign a value in the range: 0 – 100) <i>{default=0}</i>  This setting can be ignored or changed according to the Nesting configuration.





## **Tecnologie e Prodotti per l'Automazione**

Via Carducci, 221  
I - 20099 Sesto S.Giovanni (MI)  
Ph. +393666507029

[www.tpaspa.com](http://www.tpaspa.com)

[info@tpaspa.it](mailto:info@tpaspa.it)